

MISSION-CRITICAL
INTERCONNECT
SOLUTIONS



Oil & Gas / Subsea

Underwater Interconnects for High-Speed, High-Power, High-Density, and High-Pressure Applications

APRIL 2019

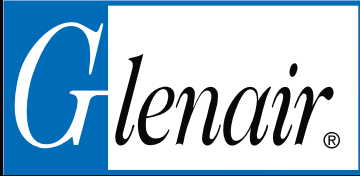

OIL & GAS INDUSTRY INTERCONNECT SOLUTIONS

- High-pressure, 10K psi open-face subsea
- Ruggedized serial and high-speed electrical connectors
- Power and fiber optic interconnects
- Hazardous zone ATEX explosion-proof
- Ultra high-density solutions for ROVs



TOP
SIDE



SHALLOW
WATER



DOWN
HOLE



DEEP
WATER

High-performance, high-pressure interconnect technologies with proven sealing performance in shipboard, downhole and underwater applications



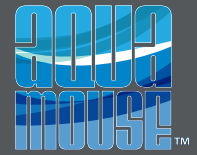

DEEP WATER SUBSEA, HIGH-PRESSURE 10K PSI / 700 BAR / 7000M CONNECTORS



SeaKing™ 10K PSI subsea connectors and cables: SeaKing 700™, SeaKing Fiber™ and SeaKing Power™

SeaKing Junior high-density small form-factor subsea connector

SuperG55™ dry-mate 10K PSI subsea electrical connectors

PIPELINE INSPECTION / ULTRAMINIATURE SUBSEA



Micro PSI microminiature high-pressure connectors and cables



SHALLOW WATER SUBSEA CONNECTORS



AquaMouse™ 3500 PSI miniature connectors and overmolded cables



Geo-Marine® 5000 PSI connectors and overmolded cables



DOWNHOLE HIGH-TEMPERATURE / HIGH PRESSURE CONNECTORS

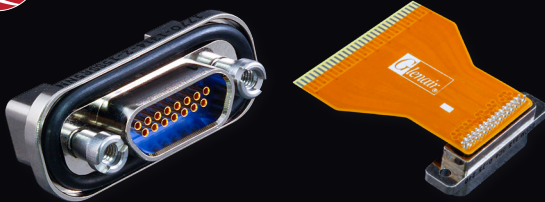

High-density, TwistPin contact Micro-D connectors

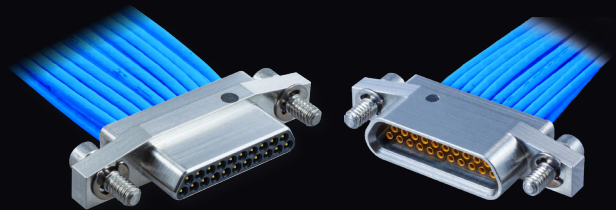

Well-Master® high temperature Micro-D connectors



TOPSIDE OR SHIPBOARD CONNECTORS



SeaCrow Marine Bronze topside power and signal connector



ITS-Ex ATEX-qualified explosive zone connectors

CABLE AND PBOF ASSEMBLIES



Harsh-environment overmolded cable assemblies

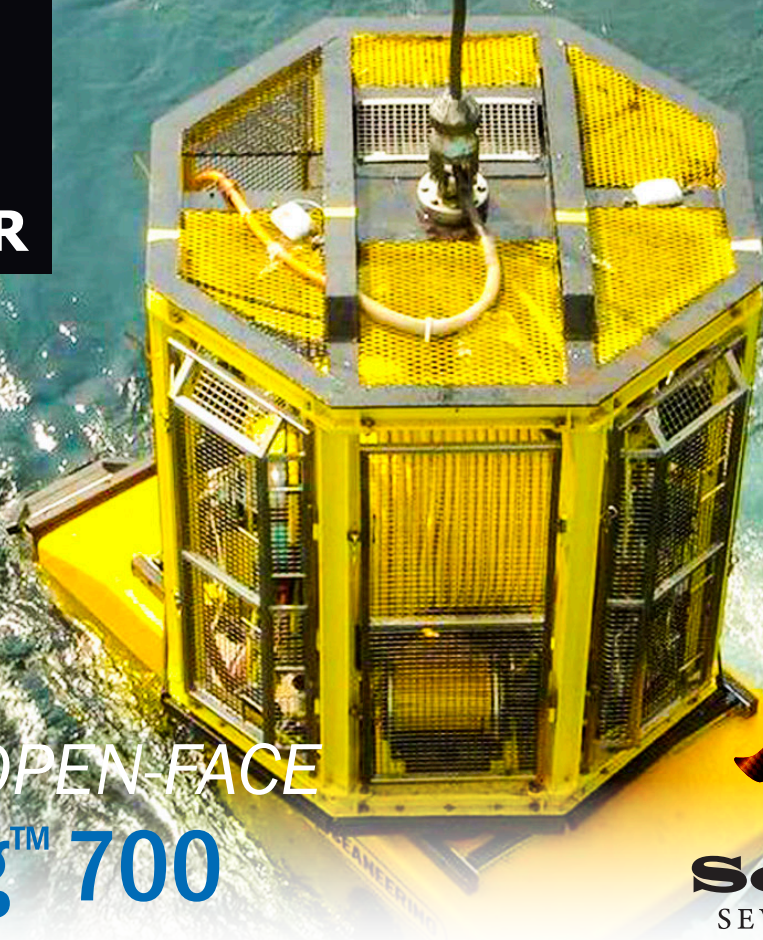

SeaKing
SEVEN HUNDRED

10K PSI OPEN-FACE SeaKing™ 700 Underwater Connectors

10K PSI / 700 Bar / 7000m open-face or mated, dual O-ring equipped, high-density, high-voltage, fiber optic and hybrid electrical/optical subsea connectors

SeaKing is an innovative underwater connector series that eliminates a broad range of mechanical design weaknesses found in many of today's high-pressure subsea connector families. From its double O-ring seals and retractable engaging nut, to its multi-keyed mating interface, the SeaKing underwater connector represents a far more reliable approach to subsea power and signal connectivity.

Ideally suited for deep water offshore oil & gas, military/defense, oceanographic research, and other harsh-environment subsea applications, the dry-mate connector series is built for optimal durability and reliability. Tested to 15,000 PSI (open face and mated), and equipped with integrated dual O-ring seals, marine bronze coupling nuts, corrosion-resistant stainless steel shells and high-pressure contact inserts with gold-plated signal contacts, special RF and fiber optic solutions, the Series 700 SeaKing is today's most advanced high-density signal and standard-density power underwater connector.

- High density, small form-factor connector
- Dual O-ring seals ensure high-pressure performance for every leak path
- Signal, power, RF and optical insert arrangements
- Stainless steel construction with anti-galling marine bronze engaging nut
- Full-mate inspection ports
- Easy O-ring replacement
- Key and keyway polarization

STANDARD CONFIGURATIONS

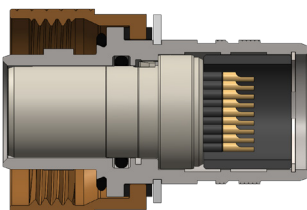

Cable Connector Plug (CCP)

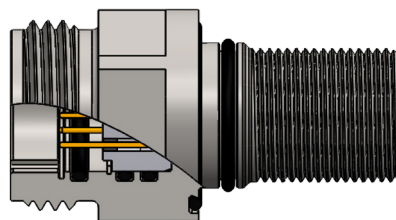

Bulkhead Connector Receptacle (BCR)

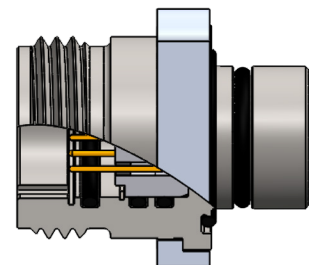

Flange Connector Receptacle (FCR)



SERIES 700 10K PSI / 700 BAR / 7000 M SeaKing™ High-Pressure Subsea Connectors, Cables, and PBOF Assemblies

Key mechanical and environmental features



Sealing: The Series 700 SeaKing™ is the best sealed subsea connector on the market. All critical interfaces, including bulkhead seals, glass-to-metal insert seals, mating interface bore seals, and face seals are fully redundant ensuring 10K PSI protection, even in the event of a single-seal failure.

Mating: SeaKing™ utilizes a modified UNC (coarse) mating interface with added clearance to reduce bio-fouling and facilitate rapid-advance mating. The marine bronze engaging nut on the plug is equipped with wrench flats as well as knurling and is less susceptible to galling than standard steel engaging nuts. Polarized keys and keyways prevent both thread damage and mismatching.

Ease-of-Use: Multiple PBOF backshell indexing points, indexable flange FCRs, full-mate inspection ports, retractable engaging nuts, and other features make SeaKing™ the most user-friendly subsea connector on the market.

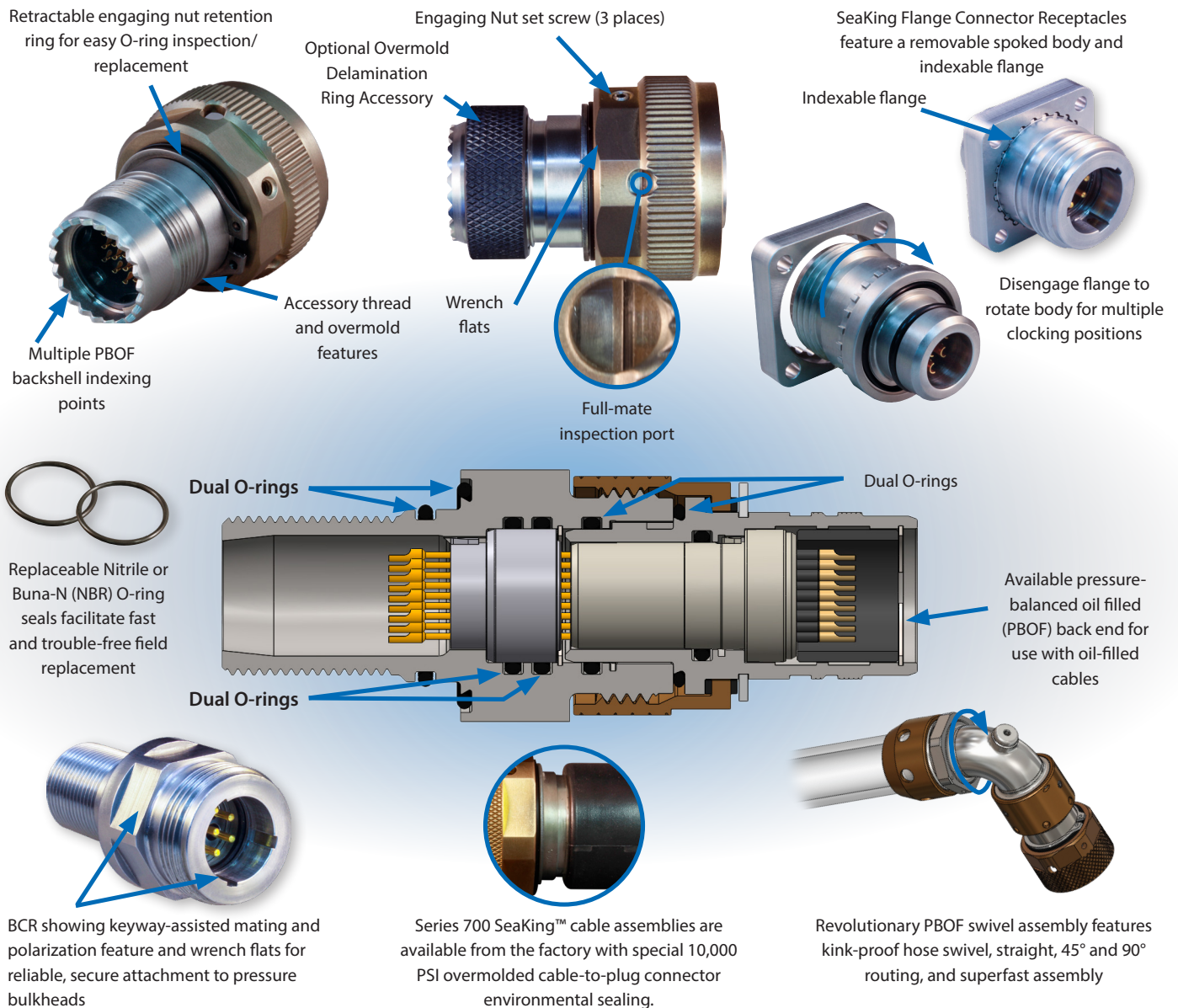



SERIES 700 10K PSI / 700 BAR / 7000 M

SeaKing™ High-Pressure Subsea Connectors, Cables, and PBOF Assemblies



Insert arrangements and specifications

SEAKING™ INSERT ARRANGEMENTS Mating face view of receptacle insert shown (plug inserts are reversed)

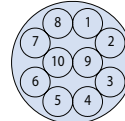
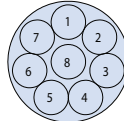
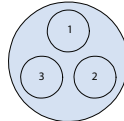

Size E	Size G		
E4	G3	G8	G10
4 Size #22 Contacts	3 Size #16 Contacts	8 Size #20 Contacts	10 Size #22 Contacts

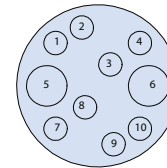
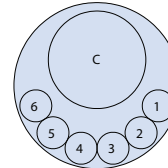
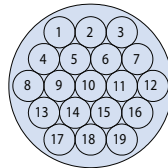
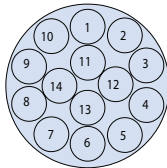
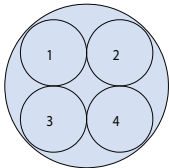

Size K				
K4	K14	K19	KC6	KX10
4 Size #16 Contacts	14 Size #20 Contacts	19 Size #22 Contacts	Single 75 Ohm Coax, 6 size #22 Contacts	10 Contacts 2 size #16, 8 size #22

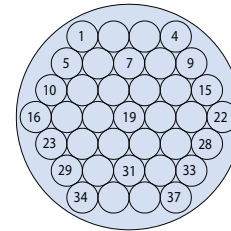
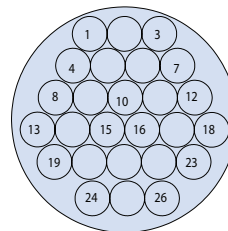
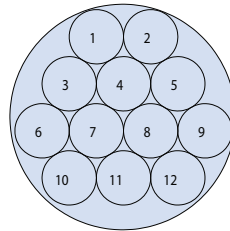
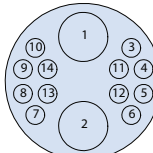
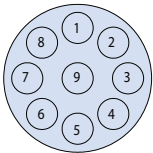

Size L				
L9	LX14	M12	M26	M37
9 Size #16 Contacts	14 Contacts 2 size #12, 12 size #22	12 Size #16 Contacts	26 Size #20 Contacts	37 Size #22 Contacts

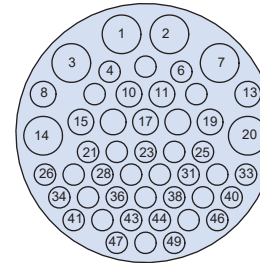
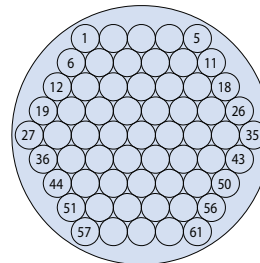
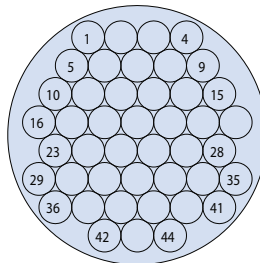
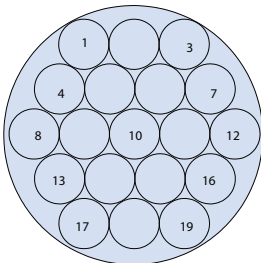

Size O			
O19	O44	O61	OX49
19 Size #16 Contacts	44 Size #20 Contacts	61 Size #22 Contacts	49 Contacts 6 size #16, 9 size #20, 34 size #22

Consult factory for custom insert arrangements including a wide range of shielded RF microwave and high frequency contact configurations



SERIES 700 10K PSI / 700 BAR / 7000 M SeaKing™ High-Pressure Subsea Connectors, Cables, and PBOF Assemblies

Insert arrangements and specifications

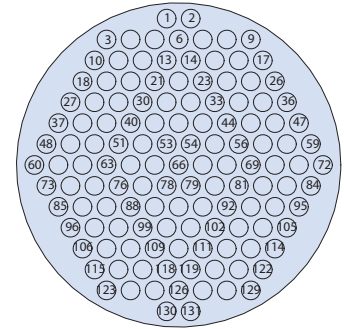
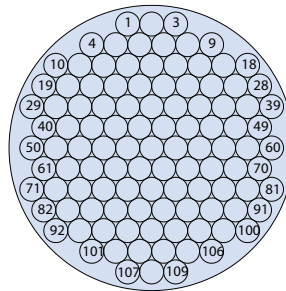
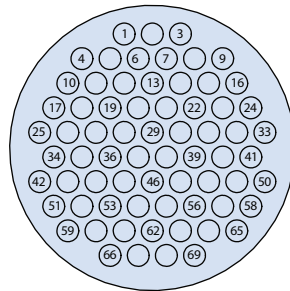
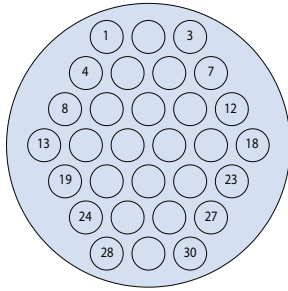

	Size Q			Size R
Q30	Q69	Q109	R131	
30 Size #16 Contacts	69 Size #20 Contacts	109 Size #22 Contacts	131 Size #22 Contacts	

Consult factory for custom insert arrangements including a wide range of shielded RF microwave and high frequency contact configurations

All high-density signal and standard-density power insert arrangements are available across the complete range of connector styles (CCP, FCR, and BCR). High-speed Ethernet inserts as well as Pressure Balanced Oil Filled (PBOF) configurations and a purpose-designed family of pressure caps, accessories and backshells are also available, please consult the factory.

SeaKing™ bulkhead connector receptacles (BCR) and flange connector receptacles (FCR) are equipped with high-pressure glass-to-metal sealed inserts with solder contact wire termination and 10K psi open-face rating. Cable connector plugs (CCP) utilize environmental O-ring sealed inserts and are rated to 10K psi in the mated condition.

Polarization		
Key Position	Key Rotation	
	A°	B°
Normal (N)	150°	210°
A	75°	210°
B	95°	230°
C	140°	275°

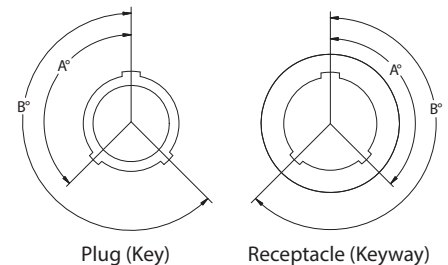

Contact Arrangement Table				
Shell Size	Contact Size			
	#22	#20	#16	Hybrid
E	4			
G	10	8	3	
K	19	14	4	KC6: 1 Coax, 6 #22 KX10: 2 #16, 8 #22
L			9	LX14: 2 #12, 12 #22
M	37	26	12	
O	61	44	19	OX49: 6 #16, 9 #20, 34 #22
Q	109	69	30	
R	131			

Contact Specifications				
Contact Size	#22	#20	#16	#12
Amps	3	5	10	17
AWG Accomodation	22	20	16	12

SeaKing™ Performance Specifications		
Pressure Rating	Plug: 10,000 psi, mated condition Receptacles: 10,000 psi mated and open face	per ISO 13628-6
Electrical	600 VDC typical	per MIL-STD-202, Method 301
	5 GOhm insulation resistance at 500 VDC	per MIL-STD-202, Method 302
Materials	Salt Spray (corrosion)	MIL-STD-202, Method 101
	Humidity (steady state)	MIL-STD-202, Method 103
	Thermal Cycle	ISO 13628-6



SERIES 700 10K PSI / 700 BAR / 7000 M
**SeaKing™ High-Pressure Subsea
 Connectors, Cables, and PBOF Assemblies**
 700 Series connectors CCP, FCR and BCR



700-001 CABLE CONNECTOR PLUG (CCP)



SeaKing - How To Order						
Sample Part Number	700	-001	-K19	-Z1	S	N
Product Series	700 = SeaKing™					
Shell Style	001 = cable connector plug (CCP)					
Shell Size-Insert Arrangement	See SeaKing insert arrangements table (pgs. 6-7)					
Shell Material	Z1 = 316 stainless steel TC = titanium					
Contact Style	S = socket					
Polarization	A, B, C, N = normal; see polarization table, pg 7					

700-006 FLANGE CONNECTOR RECEPTACLE (FCR)



SeaKing - How To Order						
Sample Part Number	700	-006	-O19	-Z1	P	N
Product Series	700 = SeaKing™					
Shell Style	006 = flange connector receptacle (FCR)					
Shell Size-Insert Arrangement	See SeaKing insert arrangements table (pgs. 6-7)					
Shell Material	Z1 = 316 Stainless steel TC = Titanium					
Contact Style	P = Pin					
Polarization	A, B, C, N = normal; see polarization table, pg 7					

700-007 BULKHEAD CONNECTOR RECEPTACLE (BCR)



SeaKing - How To Order						
Sample Part Number	700	-007	-K19	-Z1	P	N
Product Series	700 = SeaKing™					
Shell Style	007 = bulkhead connector receptacle (BCR)					
Shell Size-Insert Arrangement	See SeaKing insert arrangements table (pgs. 6-7)					
Shell Material	Z1 = 316 stainless steel TC = titanium					
Contact Style	P = pin					
Polarization	A, B, C, N = normal; see polarization table, pg 7					



SERIES 700 10K PSI / 700 BAR / 7000 M
**SeaKing™ High-Pressure Subsea
 Connectors, Cables, and PBOF Assemblies**
 700 Series, non-metallic PEEK connectors



707-0149 CABLE CONNECTOR PLUG (CCP), PEEK



SeaKing - HowTo Order						
Sample Part Number	707-0149	-1	-M12	-K	S	N
Product Series	707-0149 = SeaKing™ CCP, non-metallic PEEK					
Shell Style	001 = cable connector plug (CCP)					
Shell Size-Insert Arrangement	See SeaKing insert arrangements table (pgs. 6-7)					
Shell Material	K = 30% glass reinforced peek					
Contact Style	S = socket					
Polarization	A, B, C, N = normal; see polarization table, pg 7					

10K PSI available in smaller shell sizes. Contact factory for details.

707-0149 FLANGE CONNECTOR RECEPTACLE (FCR), PEEK

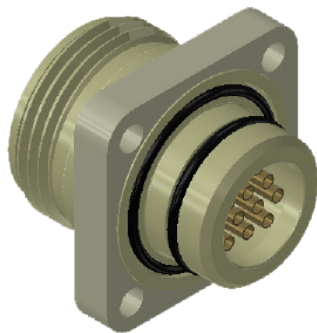

SeaKing - HowTo Order						
Sample Part Number	707-0149	-6	-M12	-K	P	N
Product Series	707-0149 = SeaKing™ FCR, non-metallic PEEK					
Shell Style	6 = flange connector receptacle (FCR)					
Shell Size-Insert Arrangement	See SeaKing insert arrangements table (pgs. 6-7)					
Shell Material	K = 30% glass reinforced peek					
Contact Style	P = pin					
Polarization	A, B, C, N = normal; see polarization table, pg 7					

10K PSI available in smaller shell sizes. Contact factory for details.

707-0149 BULKHEAD CONNECTOR RECEPTACLE (BCR), PEEK

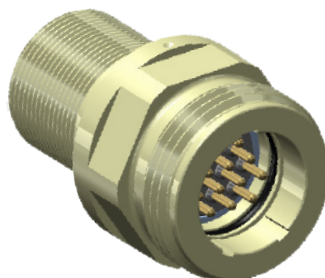

SeaKing - HowTo Order						
Sample Part Number	707-0149	-7	-M12	-K	P	N
Product Series	707-0149 = SeaKing™ BCR, non-metallic PEEK					
Shell Style	7 = bulkhead connector receptacle (BCR)					
Shell Size-Insert Arrangement	See SeaKing insert arrangements table (pgs. 6-7)					
Shell Material	K = 30% glass reinforced peek					
Contact Style	P = pin					
Polarization	A, B, C, N = normal; see polarization table, pg 7					

10K PSI available in smaller shell sizes. Contact factory for details.



SERIES 700 10K PSI / 700 BAR / 7000 M
**SeaKing™ High-Pressure Subsea
 Connectors, Cables, and PBOF Assemblies**
Receptacles with GRE insert



700-026 FLANGE CONNECTOR RECEPTACLE (FCR), WITH GRE INSERT, 10K PSI MATED CONDITION

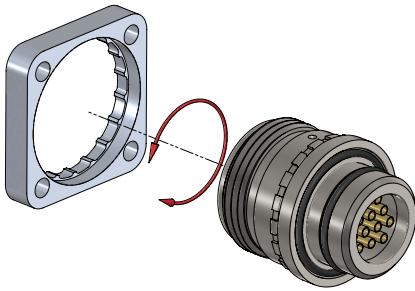

SeaKing - How To Order					
Sample Part Number	700-026	-M12	-Z1	P	N
Product Series	700-026 = SeaKing™ flange connector receptacle (FCR) with GRE insert				
Shell Size-Insert Arrangement	See insert arrangement table (pgs. 6-7)				
Shell Material	Z1 = 316 stainless steel TC = titanium				
Contact Style	P = pin				
Polarization	A, B, C, N = normal; see polarization table, pg 7				

700-027 BULKHEAD CONNECTOR RECEPTACLE (BCR), WITH GRE INSERT, 10K PSI MATED CONDITION

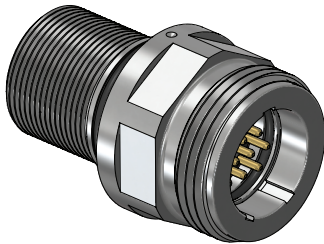

SeaKing - How To Order					
Sample Part Number	700-027	-M12	-Z1	P	N
Product Series	700 = SeaKing™ 027 = bulkhead connector receptacle (BCR) with GRE insert				
Shell Size-Insert Arrangement	See insert arrangements table (pgs. 6-7)				
Shell Material	Z1 = 316 stainless steel TC = titanium				
Contact Style	P = pin				
Polarization	A, B, C, N = normal; see polarization table, pg 7				



SERIES 700 10K PSI / 700 BAR / 7000 M SeaKing™ High-Pressure Subsea Connectors, Cables, and PBOF Assemblies



Single-ended connector receptacle pigtail assembly

7071-0012 FLANGE OR BULKHEAD CONNECTOR RECEPTACLE PIGTAIL ASSEMBLY

SeaKing - How To Order	
Sample Part Number	7071-0012 -1 -Z1 P N P N
Product Series	7071-0012 = SeaKing™
Receptacle Style	1 = 700-006 (FCR) 2 = 700-007 (BCR)
Insert Arrangement	See insert arrangements table (pgs. 6-7)
Shell Material/Finish	Z1 = 316 stainless steel TC = titanium
Cable Length	In inches
Wire Coloring	A = all white B = 10 color repeating; IAW MIL-STD-681
Polarization	A, B, C, N = normal (see polarization table, pg 7)

Alternate Key Positions		
Key Position	Key Rotation	
	A°	B°
Normal (N)	150°	210°
A	75°	210°
B	95°	230°
C	140°	275°

"Length" (see part number development) tolerance:
 +1.80/-0.00 for "L" less than or equal to 60.00 inches.
 +3%/-0.00 for "L" greater than 60.00 inches.
 minimum order length 12 inches. Consult factory for options.

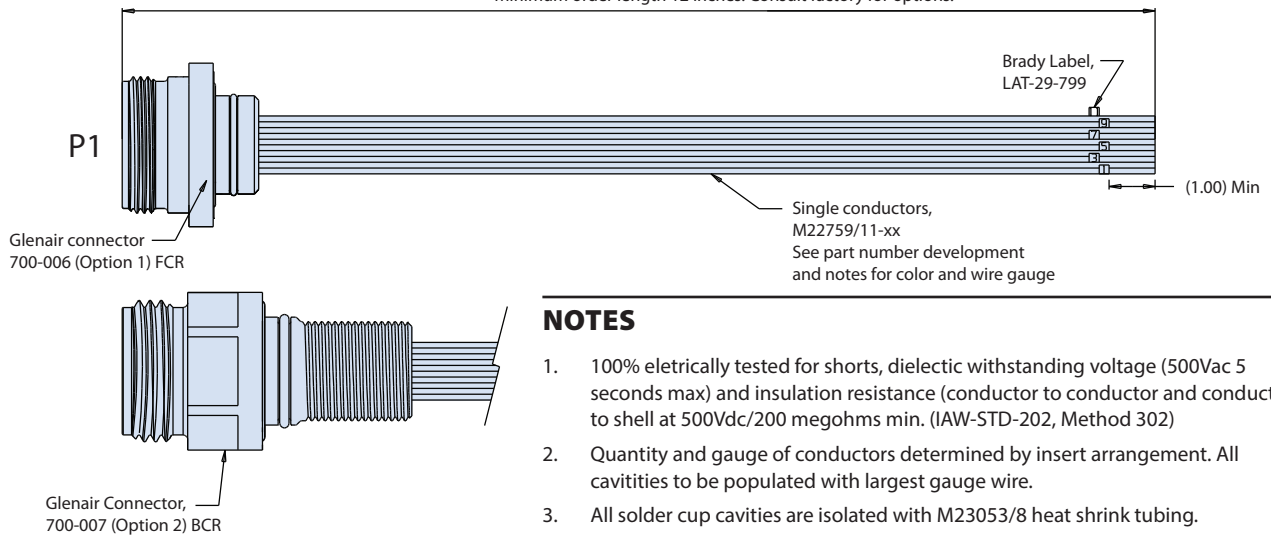

NOTES

- 100% electrically tested for shorts, dielectric withstanding voltage (500Vac 5 seconds max) and insulation resistance (conductor to conductor and conductor to shell at 500Vdc/200 megohms min. (IAW-STD-202, Method 302)
- Quantity and gauge of conductors determined by insert arrangement. All cavities to be populated with largest gauge wire.
- All solder cup cavities are isolated with M23053/8 heat shrink tubing.

NEW! 700-010 BULKHEAD CONNECTOR FEED-THRU (BCF), INCONEL INSERT, 10K PSI OPEN FACE RATED

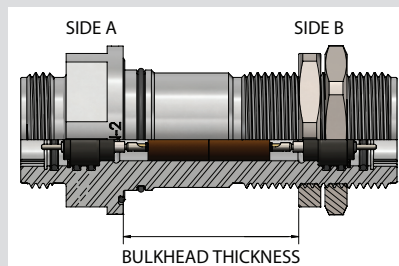

Bulkhead Thickness			
Dash No.	Bulkhead	Dash No.	Bulkhead
1	1.00 - 1.50	4	2.50 - 3.00
2	1.50 - 2.00	5	3.00 - 3.50
3	2.00 - 2.50	6	3.50 - 4.00

SeaKing - How To Order	
Sample Part Number	700-010 -M12 -Z1 P N P N -2
Product Series	700-010 = SeaKing™ bulkhead connector feed-thru (BCF)
Shell Size-Insert Arrangement	See insert Arrangements Table (pgs. 6-7)
Shell Material	Z1 = 316 stainless steel TC = titanium
Side A, Contact Style	P = pin S = socket
Side A, Polarization	A, B, C, N = normal (see polarization table, pgs. 6-7)
Side B, Contact Style	P = pin S = socket
Side B, Polarization	A, B, C, N = normal; see polarization table, pg 7
Bulkhead Thickness	1, 2, 3, 4, 5, 6; see bulkhead thickness table



SERIES 700 10K PSI / 700 BAR / 7000 M SeaKing™ High-Pressure Subsea Connectors, Cables, and PBOF Assemblies

Single ended or back-to-back, cable assembly



SeaKing - How To Order	
Sample Part Number	7071-0007 -S R Z1 -K19 N -24 11
Series	7071-0007 = SeaKing™ cable connector plug (CCP) assembly
P1	R = right angle S = straight
P2	R = right angle S = straight N=none
Shell Material/Finish	Z1 = 316 stainless steel TC = titanium
Insert Arrangement	See insert arrangement table (pgs. 6-7)
Polarization	A, B, C, N = normal; see polarization table, pg 7
Cable Length	In inches
Cap Options	10, 11, 20, 21; omit for none

Alternate Key Positions		
Key Position	Key Rotation	
	A°	B°
Normal (N)	150°	210°
A	75°	210°
B	95°	230°
C	140°	275°

Cap Options	
Sym	Description
10	Protective cap, no lanyard
11	Protective cap, with lanyard
20	Pressure cap, no lanyard
21	Pressure cap, with lanyard

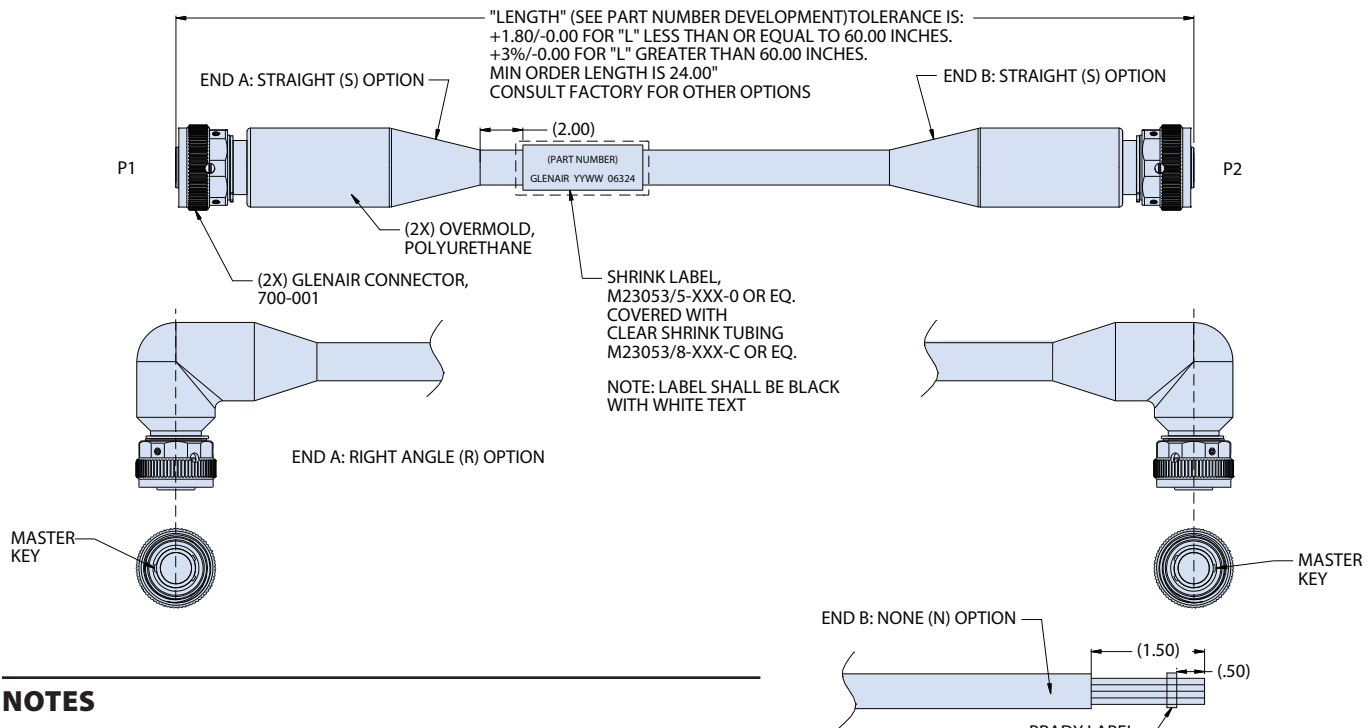

NOTES

- 100% electrically tested for shorts, dielectric withstanding voltage (at 500Vac 5 seconds max) and insulation resistance (conductor to conductor and conductor to shell) at 500Vdc/200 megohms min. IAW MIL-STD-202, Method 302)
- Unit pack: 1 ea. In poly bag, heat-sealed. Include dust cap. Tag and bag per illustration.
- Max pressure rating 10000 psi
- For connector dimensions, materials, finishes, refer to drawing 700-001.
- For insert arrangements refer to drawing 709-099 contact manufacturer for builds with combo insert arrangements
- All configurations are wired one to one.
- Pressure rated cable. Polyurethane jacket wire AWG shall be per contact size.



SERIES 700 10K PSI / 700 BAR / 7000 M SeaKing™ High-Pressure Subsea Connectors, Cables, and PBOF Assemblies PBOF assembly fittings and accessories



REVOLUTIONARY PBOF SWIVEL HOSE ATTACHMENT ACCESSORIES

Hose barb fittings for PBOF assemblies are the perennial weak link in subsea oil & gas applications. Kinked and twisted hoses, leaky fittings, corroded hose clamps, and other performance problems characterize most existing solutions. The Glenair PBOF swivel hose attachment for SeaKing™ connectors solves these problems and more. Designed from the sea floor up to perform flawlessly and reliably, this revolutionary attachment puts an end to the long list of field maintenance problems associated with oil-filled cable applications.

- Straight, 45°, and 90° “full radius” angle and profile hose routing
- Hose angle adjustment feature eliminates risk of oil leakage
- Corrosion-resistant materials used throughout
- Threaded couplers with safety set-screws for fail-safe leak and decoupling protection—no special tools required for assembly
- Compact PBOF compression fitting with 340° hose swivel action
- Support for the broad range of hose diameters and wall thicknesses

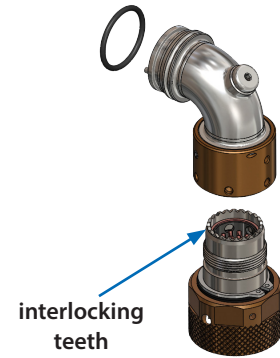

Interlocking teeth on SeaKing™ plug connectors interface with corresponding teeth on the PBOF swivel hose attachment to facilitate easy indexing and routing of hose assemblies

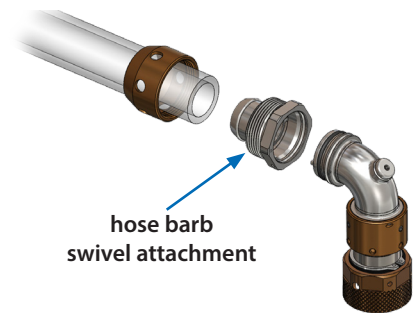

Revolutionary swivel hose barb compression attachment eliminates twisting and damage in PBOF assemblies

SeaKing PBOF Attachment Accessory Kits - How To Order	
Sample Part Number	709-003 K -L 1 S
Product Series	709-003 = SeaKing™ PBOF accessory
Shell Size	G, K, M, O, Q
Angular Function	L = Straight M = 45° N = 90°
Fill Port Option	0 = No fill port 1 = With fill port
Swivel/Fixed Option	S = Swivel F = Fixed

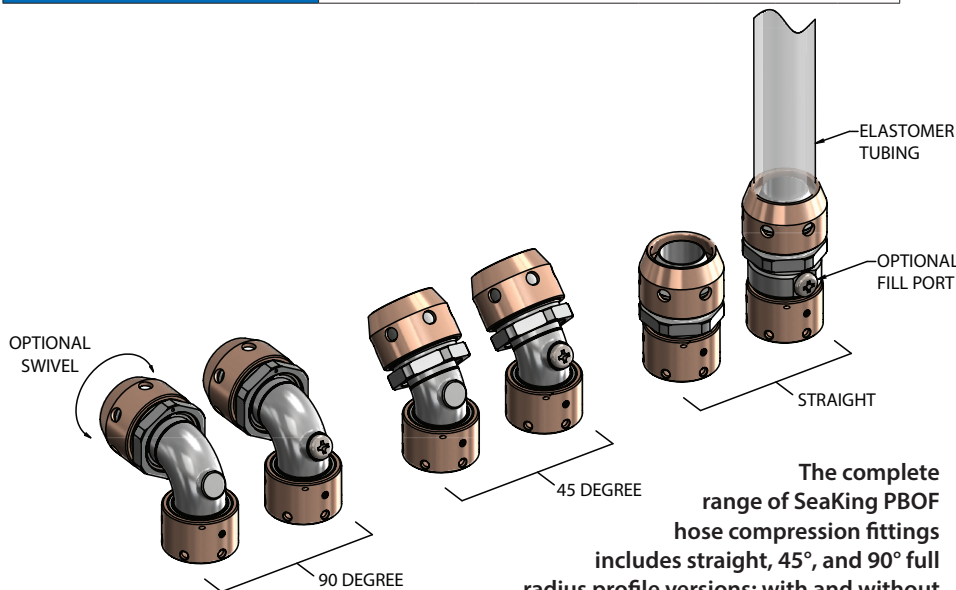

The complete range of SeaKing PBOF hose compression fittings includes straight, 45°, and 90° full radius profile versions; with and without integrated oil fill ports

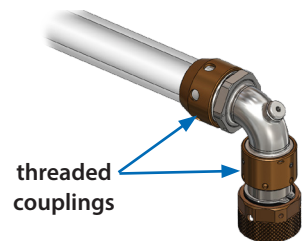

Threaded PBOF compression nut and connector coupling nut (with additional safety set screw) provide for fast and easy assembly and prevent leaks and assembly decoupling



SERIES 701 SeaKing™ Junior

High-reliability, dry-mate, harsh-environment connectors and cables for intelligent inline inspection PIGs

High-density Series 701 SeaKing Junior connectors are the perfect choice for harsh-environment oil & gas industry equipment. All designs are equipped with piston seal Nitrile O-rings to withstand exposure to corrosive chemicals and high-temperature environments. These 10,000 psi pressure rated (mated condition) connectors feature high-density crimp-contact or solder cup inserts, and are significantly smaller than our larger form-factor series 700 SeaKing interconnects. Gold-plated crimp contacts accept #12–30 gage wire. SeaKing Junior connectors are backfilled with epoxy potting compound, ready for easy incorporation into overmolded cables. Crimp-contact versions for field installation and repair are also available. SeaKing Junior is specifically designed for high-pressure, mated condition applications that do not require the extra fail-safe features and cost of an open-face rated solution.



- 10,000 psi (mated condition) pressure rated connector for overmolded (non-PBOF) applications
- High density, small form-factor solution—up to 50% reduction in size and weight compared to industry standard solutions
- Ultraminiature high-density pin configurations: #22D, #20, #20HD, #16, #12, #8 signal, power, fiber optic and high-speed datalink shielded contacts

SEAKING™ JUNIOR CABLES

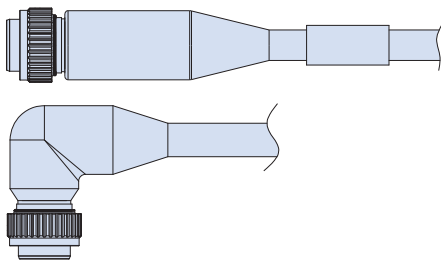

Harsh-environment polyurethane overmolded point-to-point cables with straight or right-angle ends, one-to-one wiring

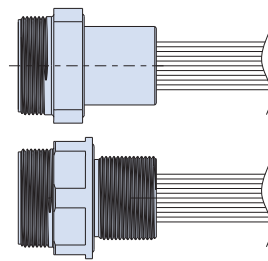

Pigtail receptacle assemblies, variable cable length, single-conductor M22759/11 wire, environmental back-end potting

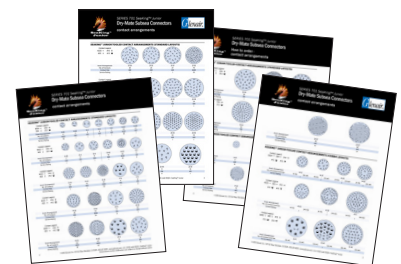

All featured insert arrangements tooled and available now including high-density and combo layouts for Coax, Twinax, and El Ochito® octaxial contacts



SERIES 701 SeaKing™ Junior Harsh-Environment Dry-Mate Connectors

10K psi (mated condition) high-density, connector series for overmolded cable applications

SERIES 701 SEAKING™ JUNIOR MECHANICAL FEATURES AND CONFIGURATIONS

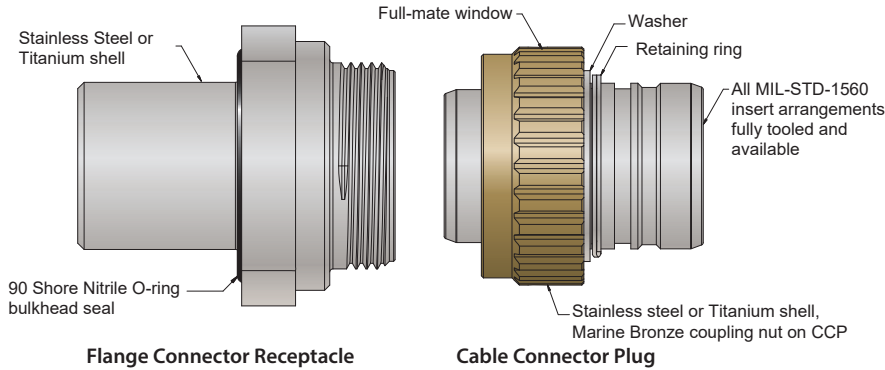

Stainless Steel or Titanium shells, Marine Bronze coupling nuts

Available in nine sizes from 2 to 128 contacts, Series 701 connectors feature stainless steel or marine bronze shells. Nitrile O-rings resist high temperature and corrosive chemicals.

10,000 psi

These connectors withstand up to 10,000 PSI hydrostatic pressure in a mated condition.

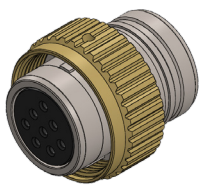

Series 701-011
Cable Connector
Plug (CCP)

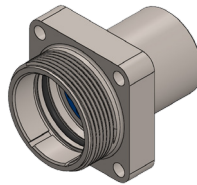

Series 701-016
Flange Connector
Receptacle (FCR)

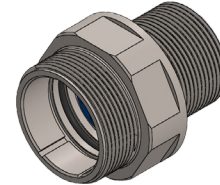

Series 701-017
Bulkhead Connector
Receptacle (BCR)

SEAKING™ JUNIOR HOW TO ORDER, SPECIFICATIONS, MATERIALS AND FINISHES

SeaKing Junior - How To Order	
Sample Part Number	701 -016 17-08 Z1 S N
Series	701 = SeaKing Junior
Connector Style	-011 = Cable Connector Plug -016 = Flange Connector Receptacle -017 = Bulkhead Connector Receptacle
Shell Size/Contact Arrangement	See Contact Arrangement tables, pages 16-21
Barrel / Shell Material	Z1 = Stainless Steel (-011 CCP supplied with Marine Bronze coupling nuts) TC = Titanium
Contact Type	P = Pin S = Socket A = Pin insert, no contacts B = Socket insert, no contacts
Key Position	N = Normal, A, B, C (see Key Positions table below)

Performance Specifications	
Current Rating	#23-5 A, #20, #22D-7.5 A, #16-13 A, #12-23 A
Insulation Resistance	5000 megohms at 500 VDC
Operating Temperature	-65° C to +175° C
Hydrostatic Pressure	10,000 PSI mated condition, tested per ISO 13628-6
Shock	300 g.
Vibration	37 g.
Durability	2000 mating cycles

Series 701 Polarization			
Key Position	Key Rotation		
	A°	B°	
Normal (N)	150°	210°	
A	75°	210°	
B	95°	230°	
C	140°	275°	

Material and Finish	
Shells, Jam Nuts	Stainless steel or Titanium
CCP Coupling Nuts	Marine bronze, unplated
Contacts	Copper alloy, gold plated.
Insulators	Composite thermoplastic
Retaining ring and hardware	Stainless steel
Interfacial Seal (pin inserts only) and Grommet	Fluorosilicone
O-rings and Seals	Nitrile, 90 shore



SERIES 701 SeaKing™ Junior Harsh-Environment Dry-Mate Connectors Insert arrangements



SEAKING™ JUNIOR TOOLED INSERT ARRANGEMENTS (STANDARD LAYOUTS)

Contact Legend
#22D • #16 ⊕
#20 ⊖ #12 ⊖

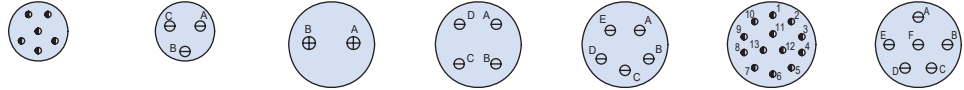

Insert Arrangement	9-35	9-98	11-2	11-4	11-5	11-35	11-98
No. of Contacts	6	3	2	4	5	13	6
Contact Size	#22D	#20	#16	#20	#20	#22D	#20
Service Rating	M	I	I	I	I	M	I

Contact Legend
#22D • #16 ⊕
#20 ⊖ #12 ⊖

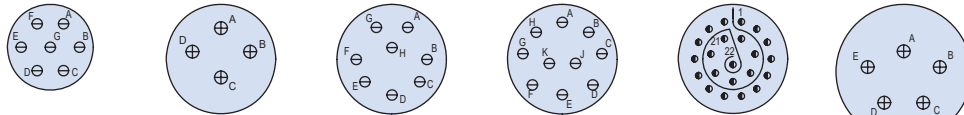

Insert Arrangement	11-99	13-4	13-8	13-98	13-35	15-5
No. of Contacts	7	4	8	10	22	5
Contact Size	#20	#16	#20	#20	#22D	#16
Service Rating	I	I	I	I	M	II

Contact Legend
#22D • #16 ⊕
#20 ⊖ #12 ⊖

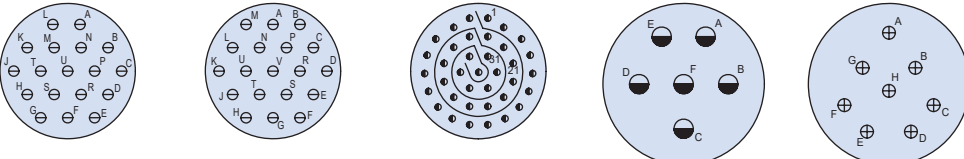

Insert Arrangement	15-18	15-19	15-35	17-6	17-8
No. of Contacts	18	19	37	6	8
Contact Size	#20	#20	#22D	#12	#16
Service Rating	I	I	M	I	II

Contact Legend
#22D • #16 ⊕
#20 ⊖ #12 ⊖

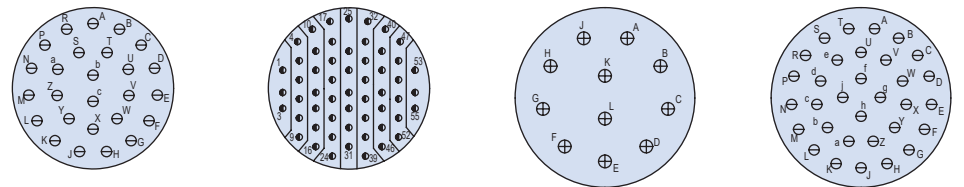

Insert Arrangement	17-26	17-35	19-11	19-32
No. of Contacts	26	55	11	32
Contact Size	#20	#22D	#16	#20
Service Rating	I	M	II	I

Contact Legend
#22D • #16 ⊕
#20 ⊖ #12 ⊖

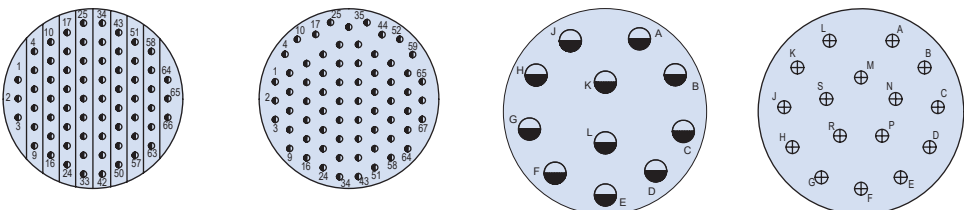

Insert Arrangement	19-35	19-45	21-11	21-16
No. of Contacts	66	67	11	16
Contact Size	#22D	#22D	#12	#16
Service Rating	M	M	I	II



SERIES 701 SeaKing™ Junior Harsh-Environment Dry-Mate Connectors Insert arrangements



SEAKING™ JUNIOR TOOLED INSERT ARRANGEMENTS (STANDARD LAYOUTS)

Contact Legend
 #22D • #16 ⊕
 #20 ⊖ #12 ●

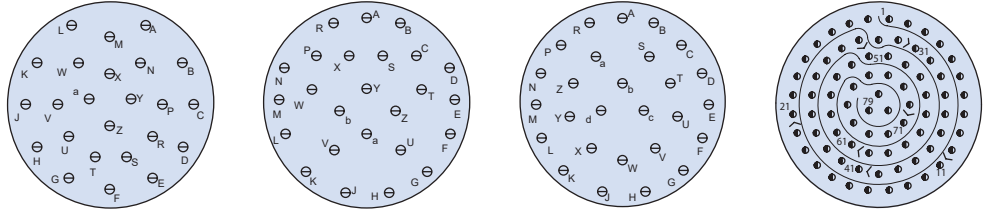

Insert Arrangement	21-24	21-25	21-27	21-35
No. of Contacts	24	25	27	79
Contact Size	#20	#20	#20	#22D
Service Rating	I	I	I	M

Contact Legend
 #22D • #16 ⊕
 #20 ⊖ #12 ●

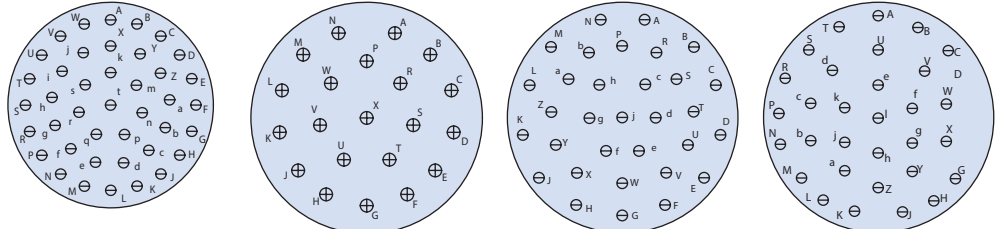

Insert Arrangement	21-41	23-21	23-32	23-34
No. of Contacts	41	21	32	34
Contact Size	#20	#16	#20	#20
Service Rating	I	II	I	I

Contact Legend
 #22D • #16 ⊕
 #20 ⊖ #12 ●

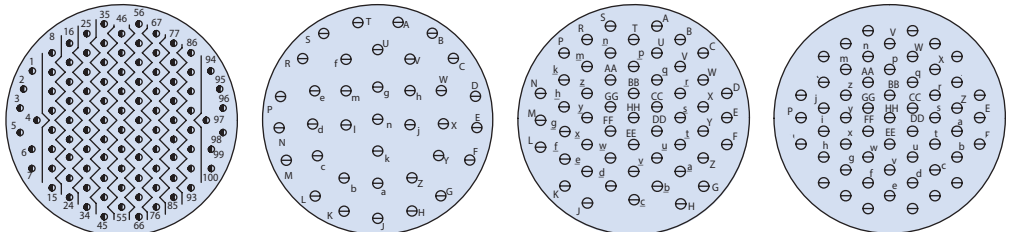

Insert Arrangement	23-35	23-36	23-53	23-55
No. of Contacts	100	36	53	55
Contact Size	#22D	#20	#20	#20
Service Rating	M	I	I	I

Contact Legend
 #22D • #16 ⊕
 #20 ⊖ #12 ●

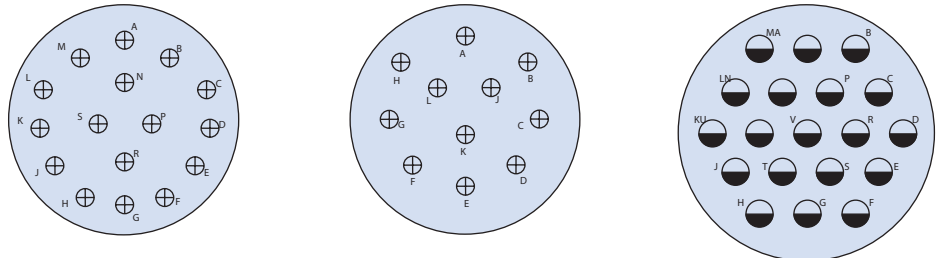

Insert Arrangement	23-97	23-99	25-19
No. of Contacts	16	11	19
Contact Size	#16	#16	#12
Service Rating	I	II	I



SERIES 701 SeaKing™ Junior Harsh-Environment Dry-Mate Connectors Insert arrangements



SEAKING™ JUNIOR TOOLED INSERT ARRANGEMENTS (STANDARD LAYOUTS)

Contact Legend
 #22D • #16 ⊕
 #20 ⊖ #12 ⊖

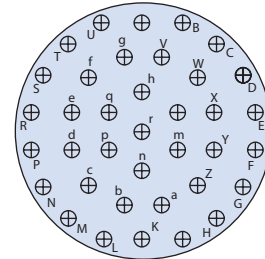
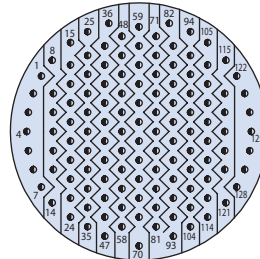
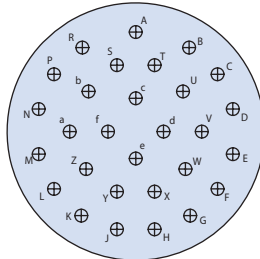

Insert Arrangement	25-29	25-35	25-37
No. of Contacts	29	128	37
Contact Size	#16	#22D	#16
Service Rating	I	M	II

Contact Legend
 #22D • #16 ⊕
 #20 ⊖ #12 ⊖

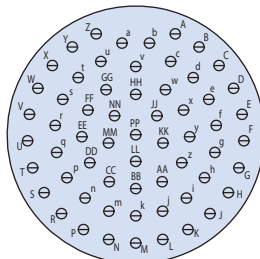

Insert Arrangement	25-61
No. of Contacts	61
Contact Size	#20
Service Rating	I

SEAKING™ JUNIOR TOOLED INSERT ARRANGEMENTS (HIGH-DENSITY LAYOUTS)

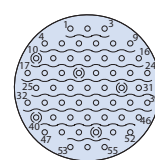
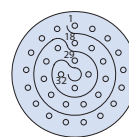
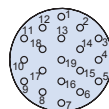

Insert Arrangement	9-23	11-23	13-23	15-23
No. of Contacts	9	19	32	55
Contact Size	#23	#23	#23	#23
Service Rating	N	N	N	N

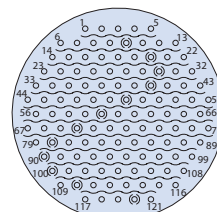
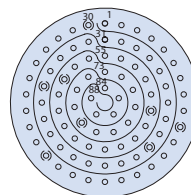
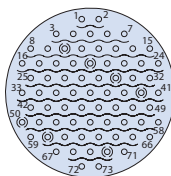

Insert Arrangement	17-23	19-23	21-23
No. of Contacts	73	88	121
Contact Size	#23	#23	#23
Service Rating	N	N	N



SERIES 701 SeaKing™ Junior Harsh-Environment Dry-Mate Connectors Insert arrangements

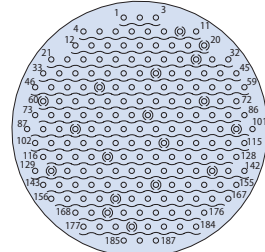
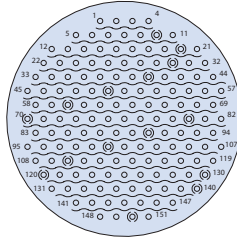

Insert Arrangement	23-23	25-23
No. of Contacts	151	187
Contact Size	#23	#23
Service Rating	N	N

SEAKING™ JUNIOR TOOLED INSERT ARRANGEMENTS (COMBO LAYOUTS)

Contact Legend
 #22D • #20 ⊖ #16 ⊕
 #12 ● #10 ⊙

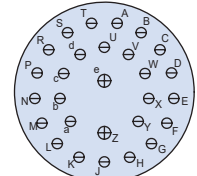
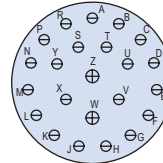
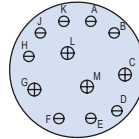
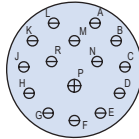

Insert Arrangement	15-15	15-97	17-99	19-28
No. of Contacts and Size	1X #16	14X #20	4X #16	8X #20
Service Rating	I	I	I	I

Contact Legend
 #22D • #20 ⊖ #16 ⊕
 #12 ● #10 ⊙

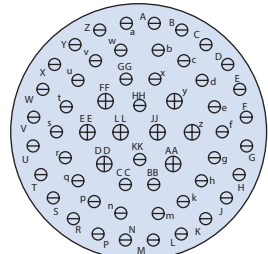
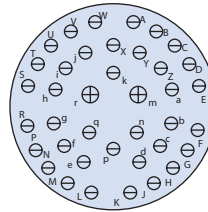
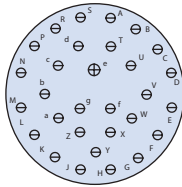

Insert Arrangement	19-30	21-39	25-4
No. of Contacts and Size	1X #16	29X #20	2X #16
Service Rating	I	I	I

Contact Legend
 #22D • #20 ⊖ #16 ⊕
 #12 ● #10 ⊙

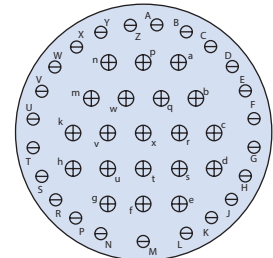
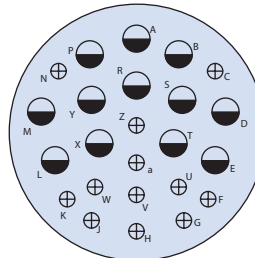
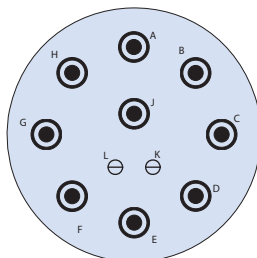

Insert Arrangement	25-11	25-24	25-43
No. of Contacts and Size	9X #10	2x #20	12X #12
Service Rating	N	I	I



SERIES 701 SeaKing™ Junior Harsh-Environment Dry-Mate Connectors Insert arrangements



SEAKING™ JUNIOR TOOLED INSERT ARRANGEMENTS (SPECIAL SHIELDED LAYOUTS)

Contact Legend
 #22D ● #16 ⊕
 #20 ⊖ #12 ◐
 #8 ●

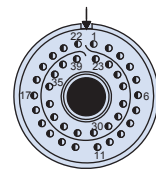
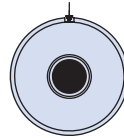
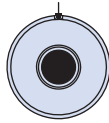

Shell Size - Insert Arrangement	9-1	11-1*	17-2
No. of Contacts	1x #8	1x #8	1x #8 38x #22D

Contact Legend
 #22D ● #16 ⊕
 #20 ⊖ #12 ◐
 #8 ●

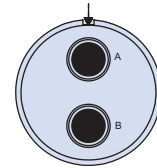
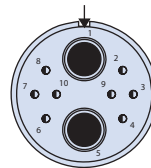
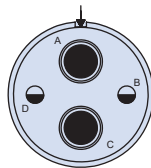

Shell Size - Insert Arrangement	17-22	17-60	17-75
No. of Contacts	2x #8 2x #12	2x #8 8x #22	2x #8

Contact Legend
 #22D ● #16 ⊕
 #20 ⊖ #12 ◐
 #8 ●

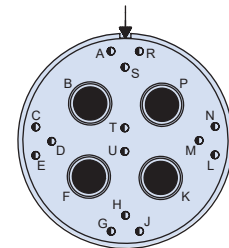
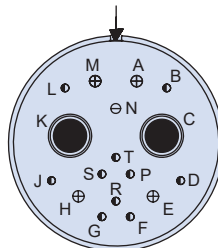
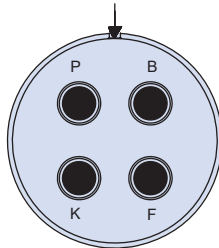

Shell Size - Insert Arrangement	19-4	19-17	19-18
No. of Contacts	4x #8	2x #8 4x #16 1x #20 10x #22D	4x #8 14x #22D

Contact Legend
 #22D ● #16 ⊕
 #20 ⊖ #12 ◐
 #8 ●

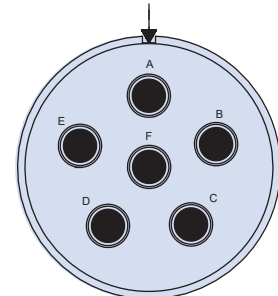
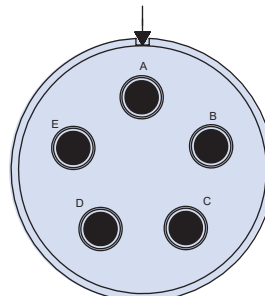
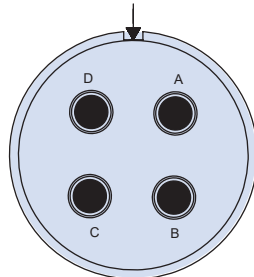

Shell Size - Insert Arrangement	21-75	23-5	23-6
No. of Contacts and Size	4x #8	5x #8	6x #8



SERIES 701 SeaKing™ Junior Harsh-Environment Dry-Mate Connectors Insert arrangements



SEAKING™ JUNIOR TOOLED INSERT ARRANGEMENTS (SPECIAL SHIELDED LAYOUTS)

Contact Legend
 #22D ● #16 ⊕
 #20 ⊖ #12 ◐
 #8 ●

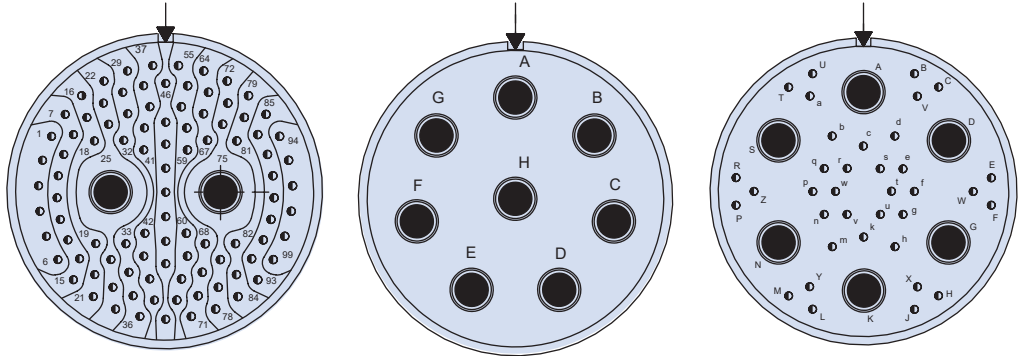

Shell Size - Insert Arrangement	25-7		25-8	25-17	
No. of Contacts and Size	2x #8	97x #22	8x #8	6x #8	36x #22

Contact Legend
 #22D ● #16 ⊕
 #20 ⊖ #12 ◐
 #8 ●

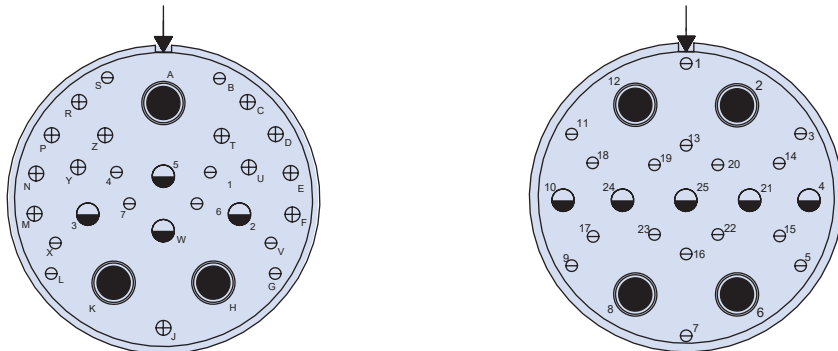

Shell Size - Insert Arrangement	25-20				25-26		
No. of Contacts and Size	3x #8	4x #12	13x #16	10x #20	4x #8	5x #12	16x #20

Contact Legend
 #22D ● #16 ⊕
 #20 ⊖ #12 ◐
 #8 ●

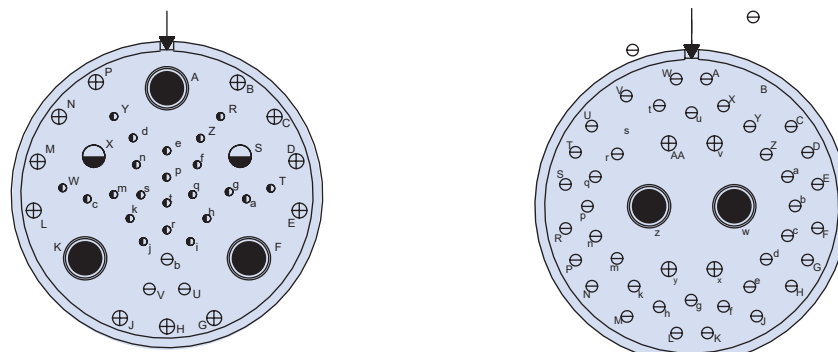

Shell Size - Insert Arrangement	25-41					25-46		
No. of Contacts and Size	3x #8	2x #12	11x #16	3x #20	22x #22D	2x #8	4x #16	40x #20

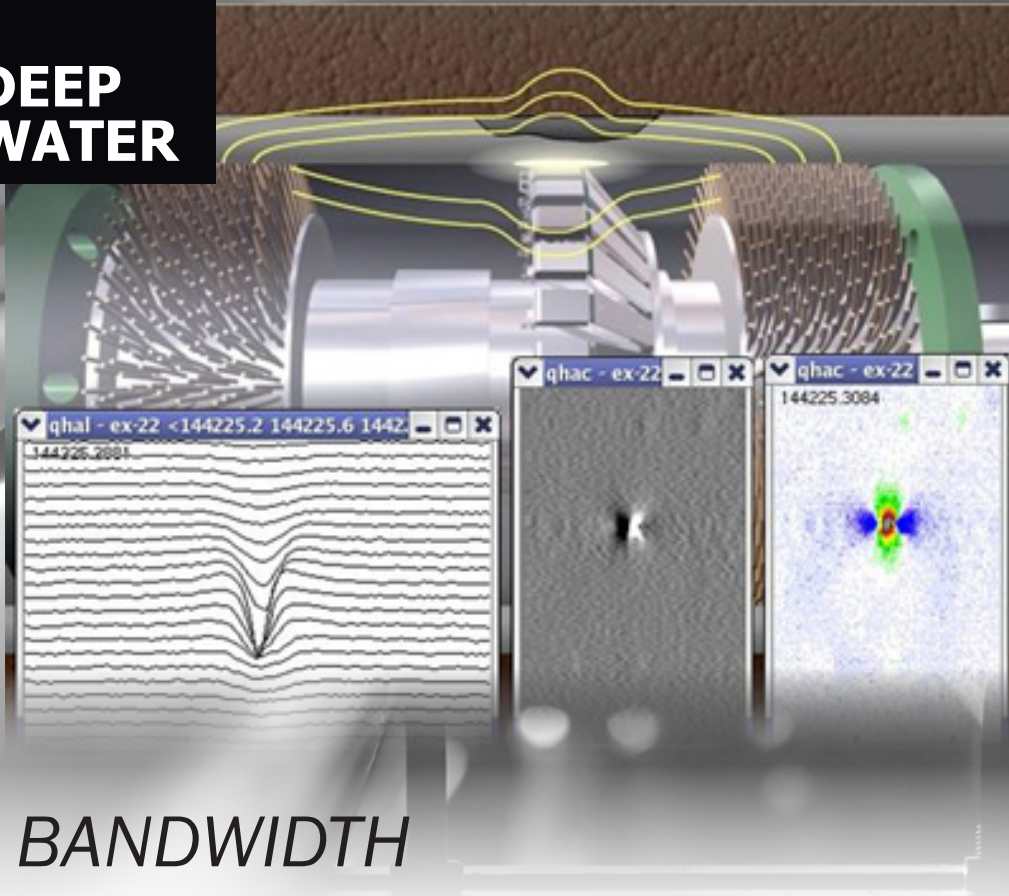

HIGH BANDWIDTH

SeaKing™ Fiber Optic

10K PSI open-face pressure rated underwater fiber optic connectors, cables and jumpers, plus ruggedized transceivers and media converters



Data-intensive applications such as towed array sonar systems, well logging and monitoring equipment, digital seismic streamers, as well as magnetic flux leakage and ultrasonic inspection sensors used in intelligent pipeline inspection are ideally suited for ruggedized high-pressure fiber optics. Fiber optic interconnect systems deliver ultra high data bandwidth, immunity from RFI and other forms of electromagnetic interference, as well as reduced size and weight compared to high-speed copper. Glenair SeaKing™ Fiber optic subsea connector solutions include harsh-environment overmolded cable assemblies, multibranch inside-the-box jumpers, as well as Glenair signature high-temp, high-vibration transceivers and optical-to-electrical media converters. Pressure-balanced oil-filled (PBOF) cable assemblies are also available for deep subsea applications.



- Overmolded and PBOF butt-joint assemblies
- Full hydrostatic qualification test report available
- Wide range of underwater optical fiber and hybrid fiber/electric layouts
- Singlemode and multimode
- <1.0db data loss for singlemode



HIGH BANDWIDTH SeaKing™ Fiber Optic



10K PSI open-face pressure-rated fiber optic connectors, cables, transceivers, and media converters

ENVIRONMENTAL OVERMOLDED FIBER OPTIC JUMPERS

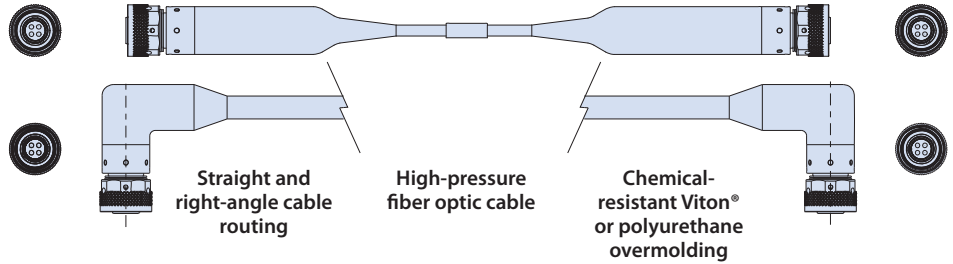

PRESSURE-BALANCED OIL-FILLED (PBOF) HIGH-PRESSURE FIBER OPTIC ASSEMBLIES

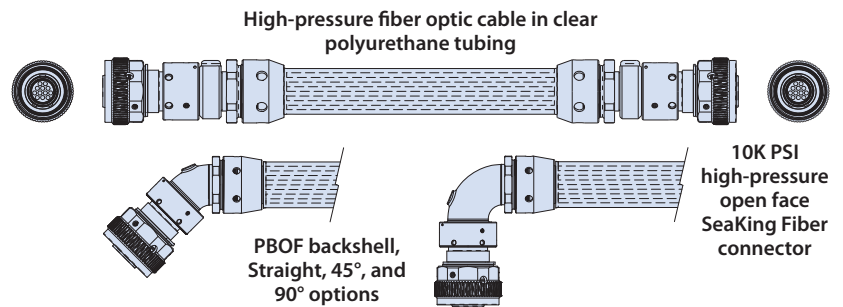

MULTIBRANCH INSIDE-THE-BOX ASSEMBLIES WITH ST-, FC-, AND LC- TYPE FIBER OPTIC CONNECTORS

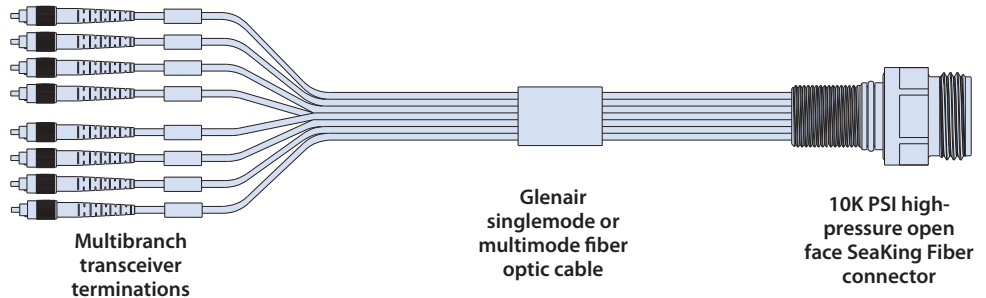

KEY AND KEYWAY POSITIONS

Alternate Keywa Positions		
Key Position	Key Rotation	
	A°	B°
Normal (N)	150°	210°
A	75°	210°
B	95°	230°
C	140°	275°

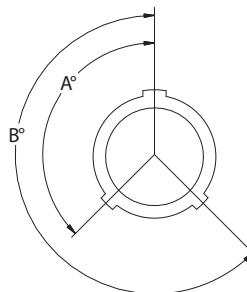

Plug (Key)

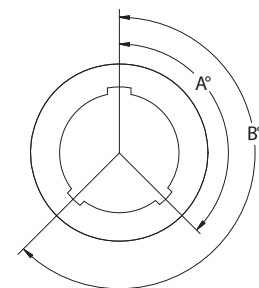

Receptacle (Keyway)



HIGH BANDWIDTH SeaKing™ Fiber



Insert Arrangements

Fiber Only

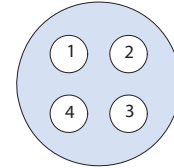
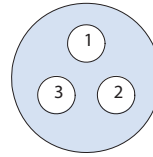
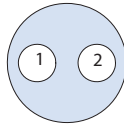

Shell Size	K	L	M
Insert Arrangement	KF2	LF3	MF4
No. of Contacts	2 FO	3 FO	4 FO

Fiber Only

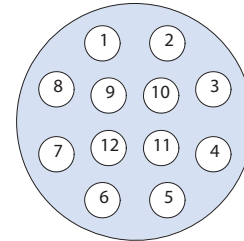
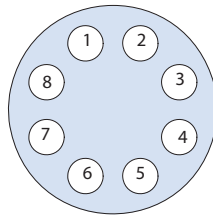

Shell Size	O	P
Insert Arrangement	OF8	PF12
No. of Contacts	8 FO	12 FO

Copper/Fiber

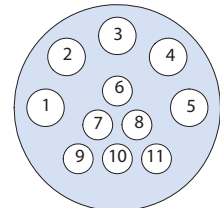
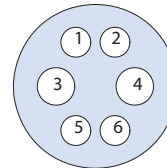
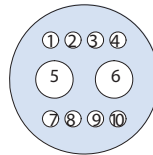
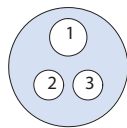

Shell Size	K	L	M	O
Insert Arrangement	KH12	LH28	MH24	OH56
No. of Fiber Contacts	1 FO	2 FO	2 FO	5 FO
No. of Copper Contacts	2 #16	8 #22	4 #16	6 #16

Copper/Fiber

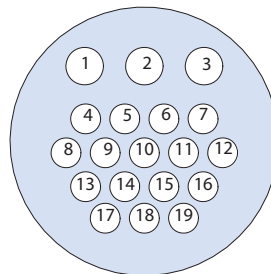
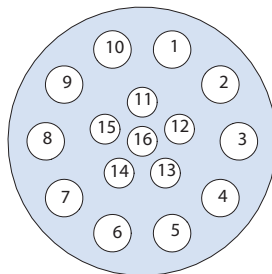

Shell Size	Q	Q
Insert Arrangement	QH106	QH316
No. of Fiber Contacts	10 FO	3 FO
No. of Copper Contacts	6 #16	16 #16

Contact Specifications		
Contact Size	#22	#16
Amps	3	10
Wire Gage Accommodation	22	16

All contact arrangements are rated for 600 volts.

Contact arrangements are shown as face view of receptacle insert. Contact arrangements of plug inserts are reverse.



HIGH BANDWIDTH SeaKing™ Fiber



Overmolded assemblies with SeaKing™ connectors or SeaKing™ to commercial fiber optic connectors

SeaKing Fiber - How To Order	
Sample Part Number	7071-0037 -C C Z1 -0F8 N -24 C
Basic Number	7071-0037
End 1 Option	C = CCP R = right angle CCP
End 2 Option	C = CCP R = right angle CCP N = none F = FC leads L = LC leads S = ST leads G = GC Leads
Shell Material	TC = titanium Z1 = 316 stainless steel
Insert Arrangement	See page 24; insert body material 316 SST
Polarization	N = normal, A, B, C; see page 23
Length	In inches
Pressure Cap Option	C = pressure cap, same size and material will be provided (709-001); omit for none

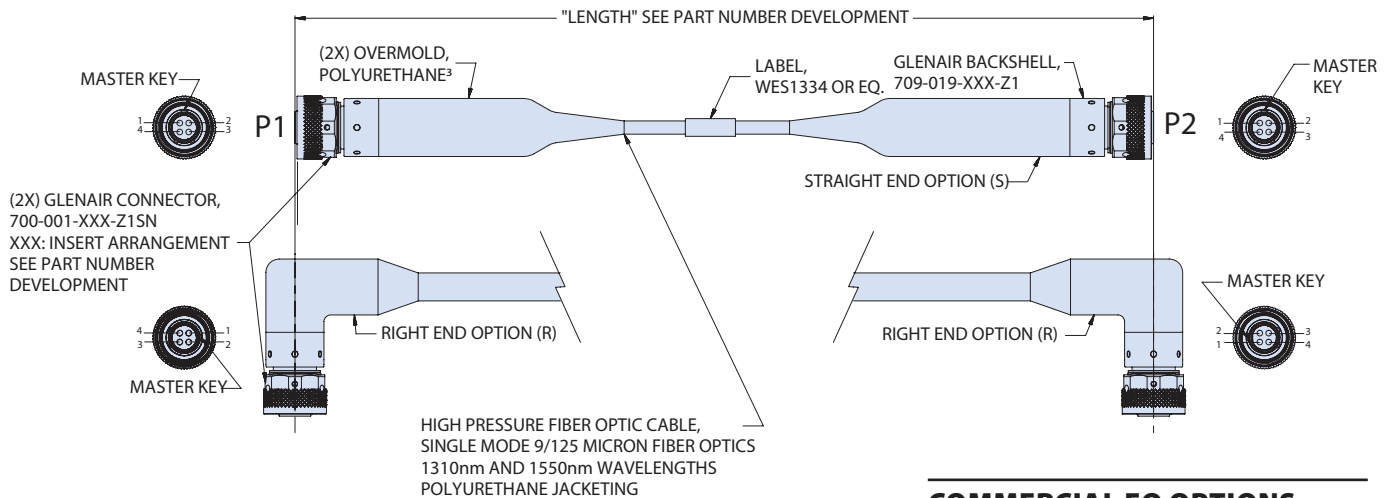

NOTES

- Optical performance:
Insertion loss shall be <1.0dB when measured @ 1310nm wavelength.
- Molding process for high pressure applications shall be used for polyurethane overmolds.
- Insert arrangement shown is for reference only. See page 24 for SeaKing fiber optic insert arrangements.
- See drawing 700-001 for connector dimensions, materials, and finishes. See PBOF assembly fittings, part number 709-003 for more information.
- Wiring for each arrangement is one to one. Fiber cavities can be populated with fiber termini and/or conductors. Electrical cavities shall be populated with largest gauge wire and contacts.
- Cables over 240" (20ft) shall be shipped on a reel.
- Kit GBS1000-00033 shall be used for inspection/cleaning.
- Recommended SeaKing terminus cleaning tool: GCLT-H160.
- Fiber optic terminus: 1.58 mm ferrule id, single O-ring.

COMMERCIAL FO OPTIONS

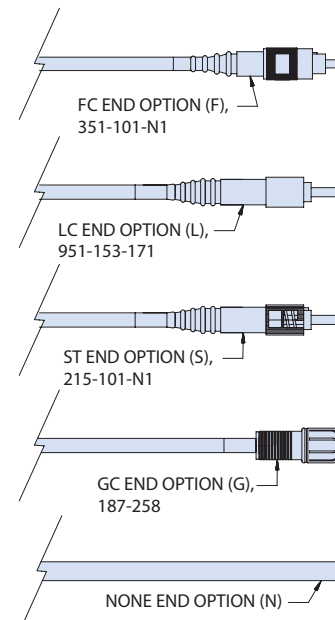



HIGH BANDWIDTH SeaKing™ Fiber



Multibranch, inside-the-box assembly with commercial fiber optic connectors to SeaKing™ connector

SeaKing Fiber - How To Order	
Sample Part Number	7071-0038 -B F Z1 -0F8 N -24 C
Basic Number	7071-0038
End 1 Option	B = BCR F = FCR
End 2 Option	F = FC leads S = ST leads L = LC leads N = none
Shell Material	TC = titanium Z1 = 316 stainless steel
Insert Arrangement	See page 24; insert body material 316 SST
Polarization	N = normal, A, B, C; see page 23
Length	In inches
Pressure Cap Option	C = pressure cap, same size and material will be provided (709-002); omit for none

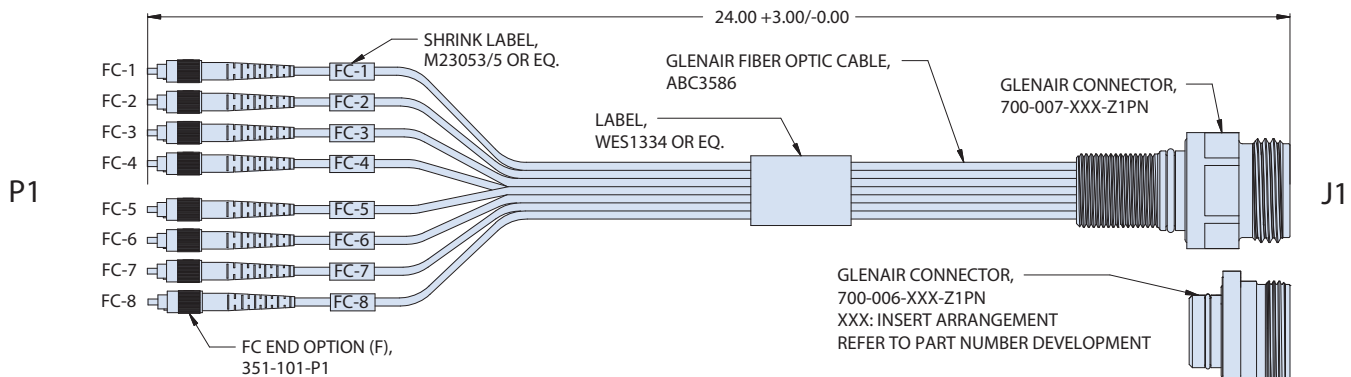

NOTES

- Optical performance: insertion loss shall be <1.0dB when measured @ 1310nm wavelength. (See note 4)
- Insert arrangement shown is for reference only. See SeaKing fiber optic insert arrangements on page 24.
- See drawing 700-001 for connector dimensions, materials, and finishes. See PBOF assembly fittings, 709-003, for more information.
- Wiring for each arrangement is one to one. Fiber cavities can be populated with fiber termini and/or conductors. Electrical cavities shall be populated with largest gauge wire and contacts.
- Kit GBS1000-00033 shall be used for inspection/cleaning.
- Recommended seaking cleaning tool: GCLT-H160.
- Fiber optic terminus: 1.58 mm ferrule id, single O-ring.

COMMERCIAL FO OPTIONS

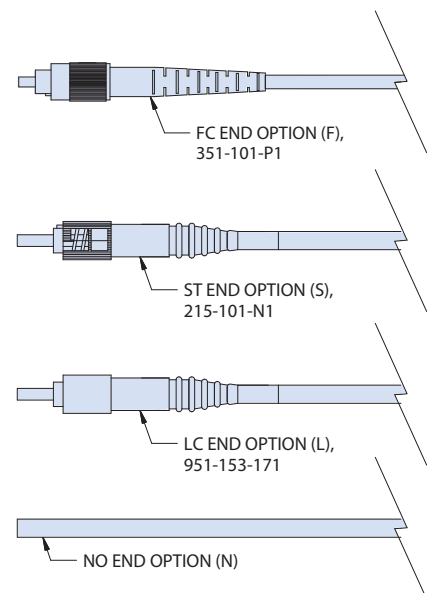



HIGH BANDWIDTH SeaKing™ Fiber



PBOF fiber optic back-to-back assembly with straight, 45° or 90° connectors

SeaKing Fiber - How To Order						
Sample Part Number	7071-0049	-S	S	MF4	-36	N
Basic Number	7071-0049					
Bckshell End Option (P1)	S = straight	R = right	F = 45°			
Bckshell End Option (P2)	S = straight	R = right	F = 45°			
Insert Arrangement	See page 24; Insert body material 316 SST					
Cable Length	In inches					
Polarization	N = normal; see page 23					

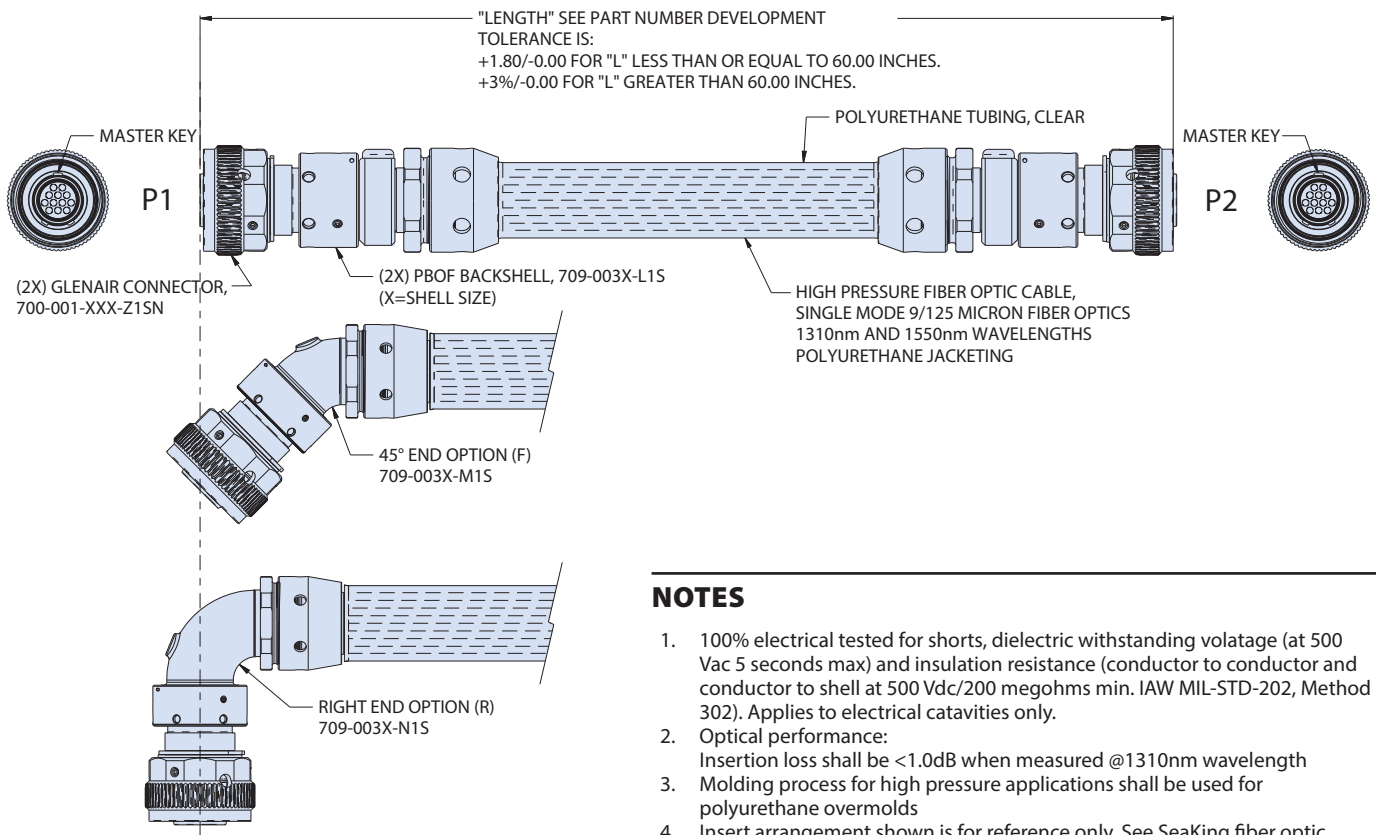

NOTES

- 100% electrical tested for shorts, dielectric withstanding volatage (at 500 Vac 5 seconds max) and insulation resistance (conductor to conductor and conductor to shell at 500 Vdc/200 megohms min. IAW MIL-STD-202, Method 302). Applies to electrical catavities only.
- Optical performance:
Insertion loss shall be <1.0dB when measured @1310nm wavelength
- Molding process for high pressure applications shall be used for polyurethane overmolds
- Insert arrangement shown is for reference only. See SeaKing fiber optic insert arrangements on page 24.
- Wiring shall be one-to-one for all insert arrangements
- Cables over 240" (20ft) shall be shipped on a reel.
- Kit GBS1000-00033 shall be used for inspection/cleaning.
- Recommended SeaKing cleaning tool: GCLT-H160.
- All solder cup cavities are isolated with M23053/8 heat shrink tubing.
- See drawing 700-001 for connector dimensions, materials, and finishes. See PBOF assembly fittings (709-003) for more information.
- Wiring for each arrangement is one to one. Fiber cavities can be populated with fiber termini and/or conductors. Electrical cavities shall be populated with largest gauge wire and contacts.
- Fiber optic terminus: 1.58 mm ferrule id, single o-ring.



HIGH BANDWIDTH SeaKing™ Fiber



PBOF fiber optic assembly with straight, 45° and 90° connectors to commercial grade fiber optic connectors

SeaKing Fiber - How To Order	
Sample Part Number	7071-0050 -S F MF4 -XX -XX N
Basic Number	7071-0050
Backshell End Option (P1)	S = Straight R = Right F = 45°
Fiber End Option	F, L, S, G, N
Insert Arrangement	See page 24; Insert body material 316 SST
Cable Length	In inches
Tube Cut Length	In inches
Polarization	N = Normal; see page 23

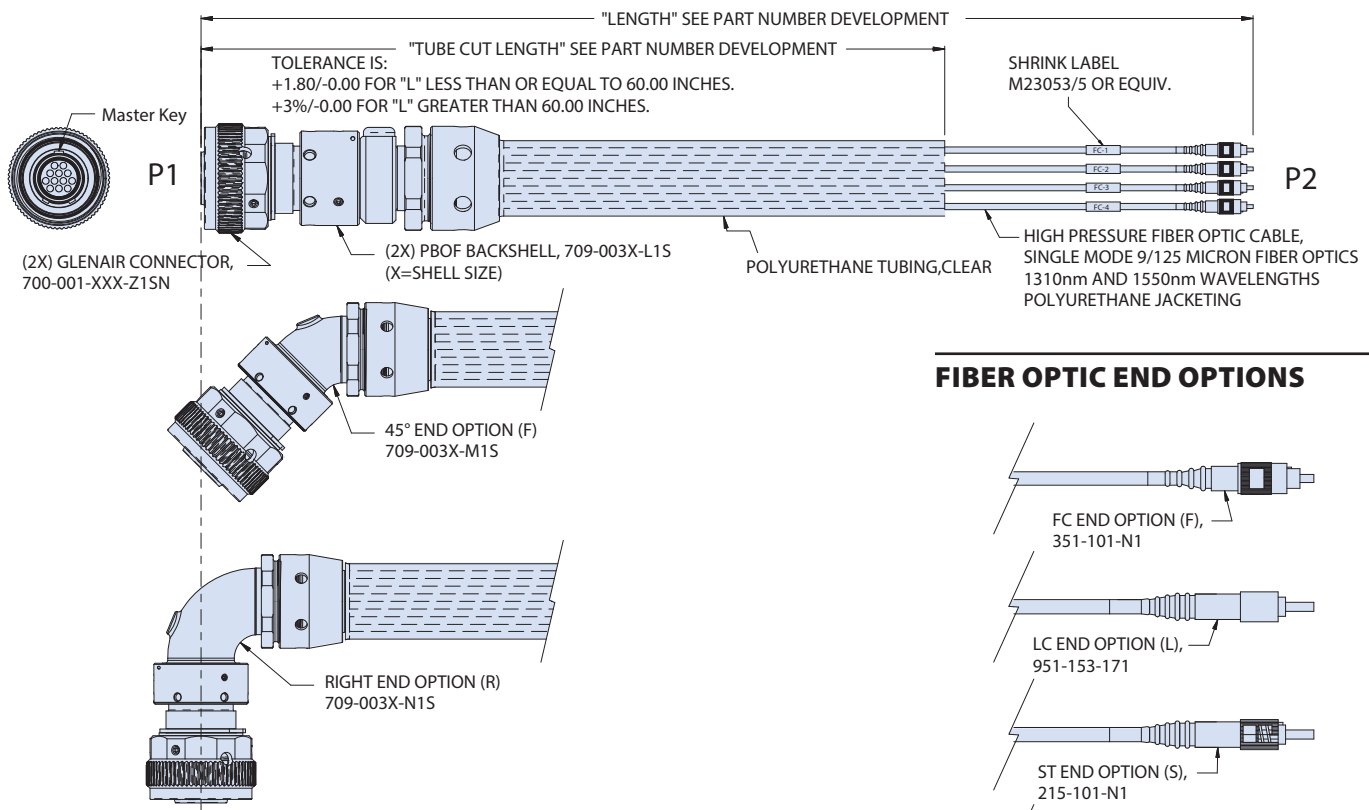

FIBER OPTIC END OPTIONS

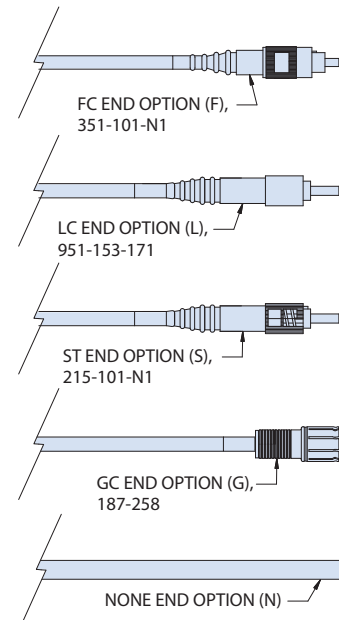

NOTES

- Optical performance:
Insertion loss shall be <1.0dB when measured @ 1310nm wavelength. (See note 4)
- Insert arrangement shown is for reference only. See SeaKing fiber optic insert arrangements on page 24.
- See drawing 700-001 for connector dimensions, materials, and finishes. See PBOF assembly fittings, 709-003, for more information.
- Wiring for each arrangement is one to one. Fiber cavities can be populated with fiber termini and/or conductors. Electrical cavities shall be populated with largest gauge wire and contacts.
- Kit GBS1000-00033 shall be used for inspection/cleaning.
- Recommended SeaKing cleaning tool: GCLT-H160.
- Fiber optic terminus: 1.58 mm ferrule id, single O-ring.

SeaKing™ Power

1–5kV connectors for deep sea oil & gas primary power junctions



Glenair's SeaKing Power connector family is rated to 10K PSI in open-face or mated condition. Selected connectors are offered with API-compliant test ports. These high-voltage (1–5kV) and high-amperage (up to 350 Amps) solder cup contact connectors are ready for immediate deployment in overmolded or PBOF configurations for primary power junction applications. A range of shell sizes and contact inserts are available.

- **API-compliant test ports**
- **Fully redundant dual O-ring sealing**
- **Indexable flange or threaded bulkhead designs**
- **O-ring pressure inspection ports available on all BCR and FCR designs**
- **Factory acceptance testing in both mated and open-face conditions**
- **Keyed mating interface for mismatch prevention**

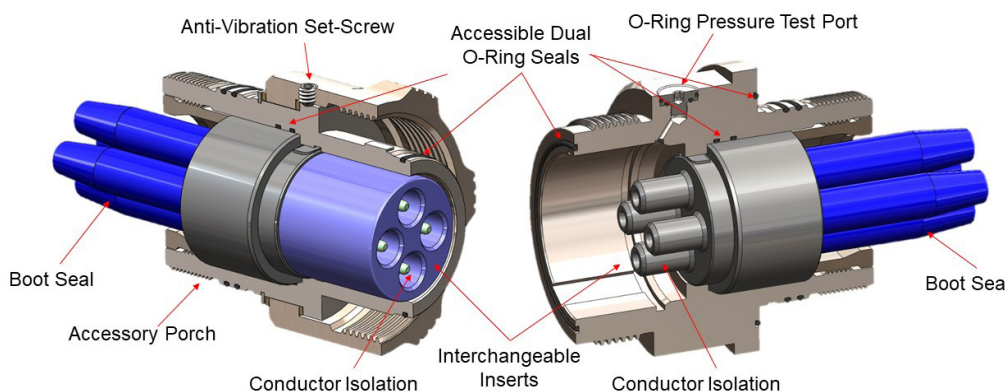



HIGH VOLTAGE SeaKing™ Power connectors for subsea primary power junctions



Available configurations and applications

CABLE CONNECTOR PLUG (CCP)

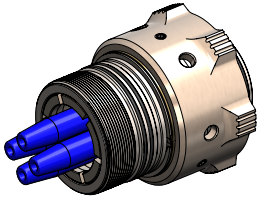

SeaKing™ Power
API-Compliant
Cable Connector Plug (CCP)

- PBOF and overmold compatible cable connector plug
- Super duplex stainless steel or titanium construction with glass-reinforced thermoplastic insulator
- Accepts various backshell accessories
- Aggressive coupling nut knurling for easy field mating
- Inspection ports, spanner wrench holes, and coupling nut lock set screws ensure reliable foolproof performance
- Mates with SeaKing Power receptacle assemblies with similar contact arrangement
- Conductor sealing boots protect solder cup wire-to-contact terminations in the event of a flooded hose

FLANGE CONNECTOR RECEPTACLE (FCR)

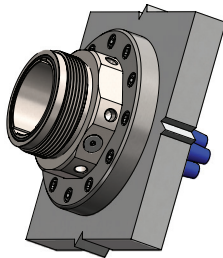

SeaKing™ Power
API-Compliant
Flange Connector Receptacle (FCR)

- FCR delivers 10K PSI sealing in both mated and open-face condition
- Indexable flange allows receptacle shell rotation for 360° routing flexibility of right-angle-mating cable plugs
- Available API O-ring pressure test ports ensure reliability prior to deployment to ocean floor
- Super duplex stainless steel or titanium shells for complete compatibility with mating CCP
- Wire sealing boots ensure reliable environmental protection of cable-to-connector interface

BULKHEAD CONNECTOR RECEPTACLE (BCR)

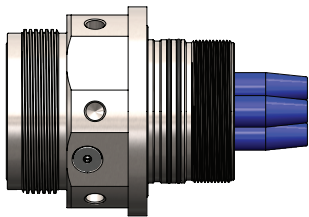

SeaKing™ Power
API-Compliant
Bulkhead Connector Receptacle (BCR)

- BCR is designed for direct threaded bulkhead mounting
- Supplied washer, mounting nut, and bulkhead-mate O-ring seals ensure secure sealing and grounding to equipment housing
- BCR shell equipped with both wrench flats and spanner wrench holes for convenient installation regardless of tool choice
- Available API O-ring pressure test ports ensure reliability prior to deployment
- Mates with SeaKing Power CCP with similar contact arrangement

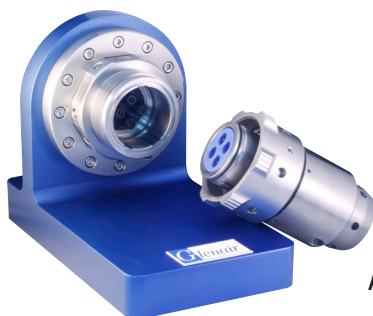

SeaKing™ Power Performance Specifications		
Pressure Rating	Plug: 10,000 psi, mated condition Receptacles: 10,000 psi mated and open face	per ISO 13628-6
Electrical	1-5kV, 50-350 Amps per contact	per MIL-STD-202, Method 301
Materials	Salt Spray (corrosion) Humidity (steady state) Thermal Cycle	MIL-STD-202, Method 101 MIL-STD-202, Method 103 ISO 13628-6

API 16D and 17E compliant SeaKing Power connector technologies are suitable for use in blowout prevention systems, riser monitor systems, and other subsea drilling and control equipment sets



HIGH VOLTAGE SeaKing™ Power connectors for subsea primary power junctions



Size 48, 4-way #8 HV contacts, 5kV, 50 amps/contact

How to Order SeaKing Power connectors	
Sample Part Number	700-101 -48HV4 Z1 S N
Series	700-101 = cable connector plug 700-106 = bulkhead or flange connector receptacle (BCR OR FCR)
Shell Size / Insert Arrangement	-48HV4 = shell size 48 / layout HV4
Shell Material	Z1 = SS super duplex TC = titanium
Contact Style	P = pins S = sockets
Polarization	N = normal, A, B, C; see key positions table at right
Mounting Option*	B = BCR option includes bulkhead nut and washer F = FCR option and includes indexable mounting flange (fastener not included) N = None, receptacle is mountable to a threaded bulkhead
Shell Option*	API = test ports; leave blank for none

Key Positions		
Position	A	B
N	150°	210°
A	75°	210°
B	95°	230°
C	140°	275°

*Options only available for 707-106-48 receptacle connector only

700-101-48 SEAKING POWER, CABLE CONNECTOR PLUG (CCP), SIZE 48, 4-WAY #8 HV CONTACTS

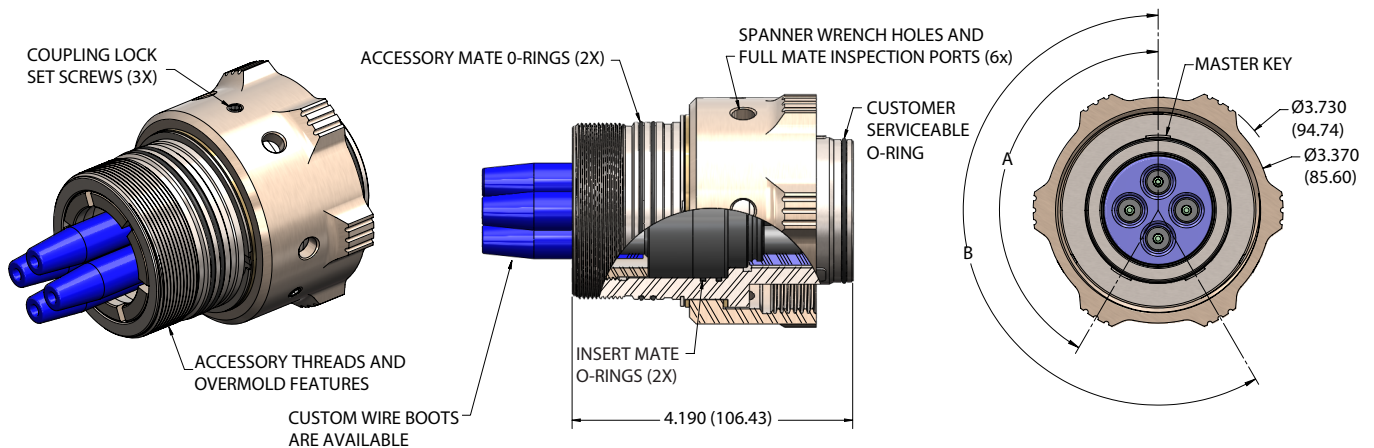

700-106-48 SEAKING POWER, FLANGE OR BULKHEAD CONNECTOR RECEPTACLE (FCR OR BCR), SIZE 48, 4-WAY #8 HV CONTACTS

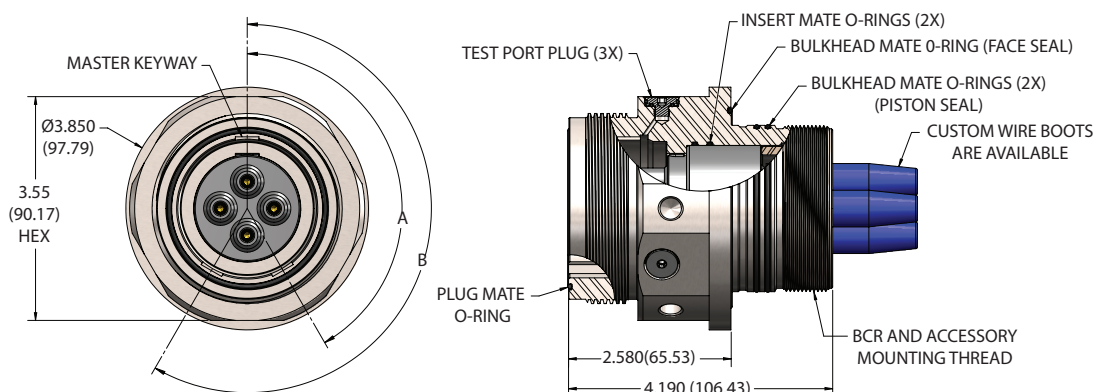



HIGH VOLTAGE SeaKing™ Power connectors for subsea primary power junctions



Size P, 4-way #8 HV contacts, 1kV, 50 amps/contact

How to Order SeaKing Power Connectors					
Sample Part Number	707-0065	-P4	-Z1	S	N
Series	707-0065 = cable connector plug (CCP) 707-0066 = bulk head receptacle (BCR)				
Shell Size / Insert Arrangement	P4				
Shell Material	Z1 = stainless steel TC = titanium				
Contact Style	P = pin (707-0066 only) S = socket (707-0065 only)				
Polarization	N = Normal, A, B, C; see key positions table at right				

Key Positions		
Position	A	B
N	150°	210°
A	75°	210°
B	95°	230°
C	140°	275°

707-0065-P4 SEAKING POWER, CABLE CONNECTOR PLUG (CCP), SIZE P, 4-WAY #8 HV CONTACTS

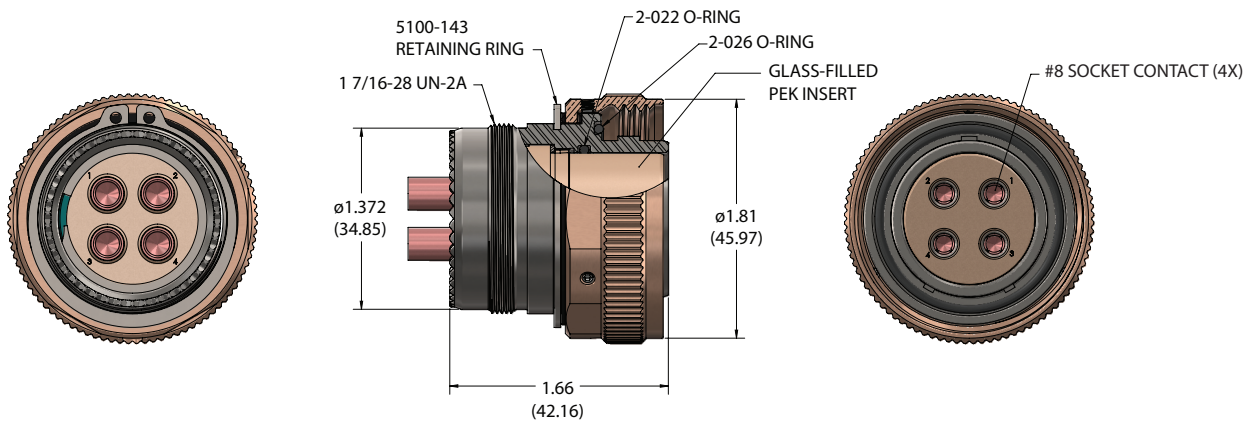

707-0066-P4 SEAKING POWER, BULKHEAD CONNECTOR RECEPTACLE (BCR) INSERT, SIZE P, 4-WAY #8 HV CONTACTS

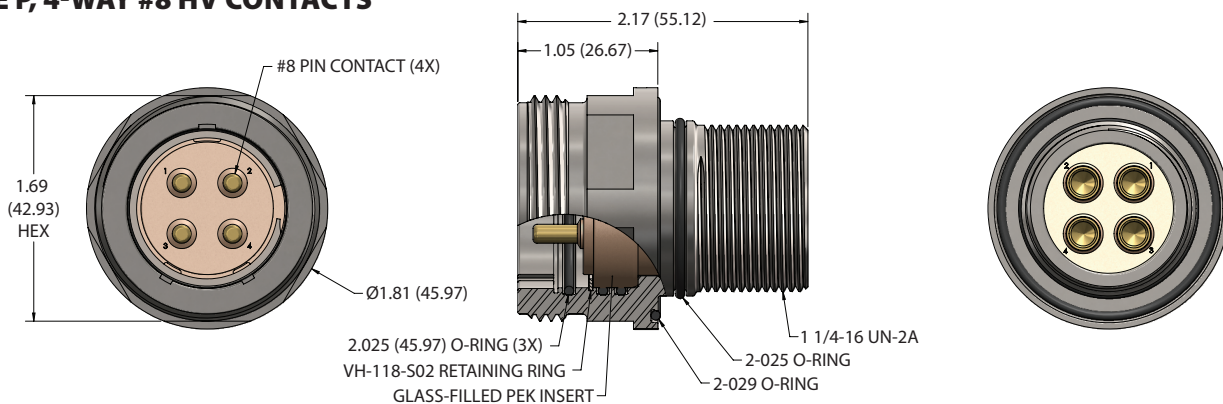



HIGH VOLTAGE SeaKing™ Power connectors for subsea primary power junctions



Size 32, 1-way #1/0 HV contact, 1kV, 150 amps/contact

How to Order SeaKing Power Connectors	
Sample Part Number	707-0089 Z1 P N -N -API
Series	707-0088 = cable connector plug 707-0089 = flange connector receptacle or bulkhead connector receptacle
Shell Material	Z1 = stainless steel TC = titanium
Contact Style	P = pin S = socket
Polarization	N = normal, A, B, C; see key positions table at right
Mounting Option*	B = BCR option and includes bulkhead nut and washer F = FCR option and includes indexable mounting flange N = none, receptacle is mountable to a threaded bulkhead
Shell Option*	API = test ports; leave blank if none

Key Positions		
Position	A	B
N	150°	210°
A	75°	210°
B	95°	230°
C	140°	275°

*Options apply to 707-0089 (FCR/BCR) receptacle connector only

707-0088 SEAKING POWER, CABLE CONNECTOR PLUG (CCP), SIZE 32, 1-WAY #1/0 HV CONTACTS

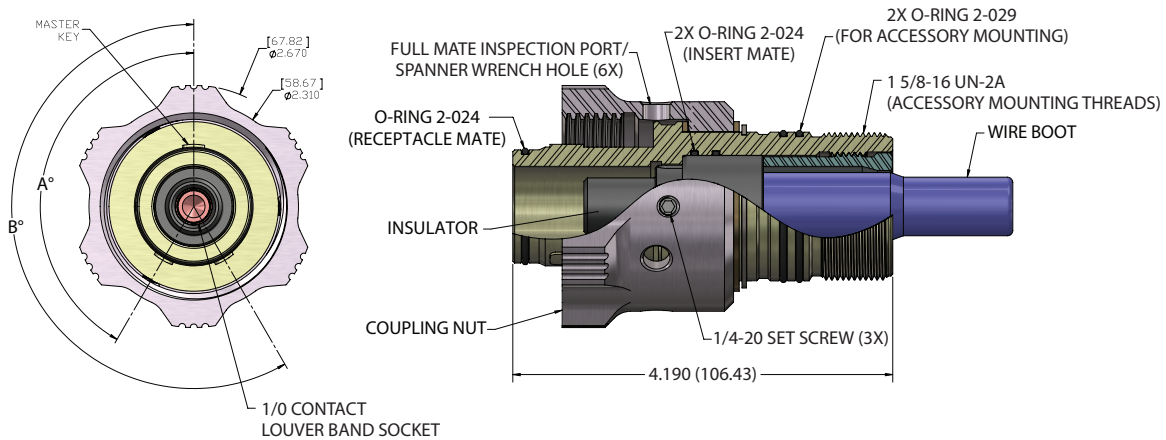

707-0089 SEAKING POWER, FRONT / BULKHEAD CONECTOR RECEPTACLE (FCR/BCR), SIZE 32, 1-WAY #1/0 CONTACTS

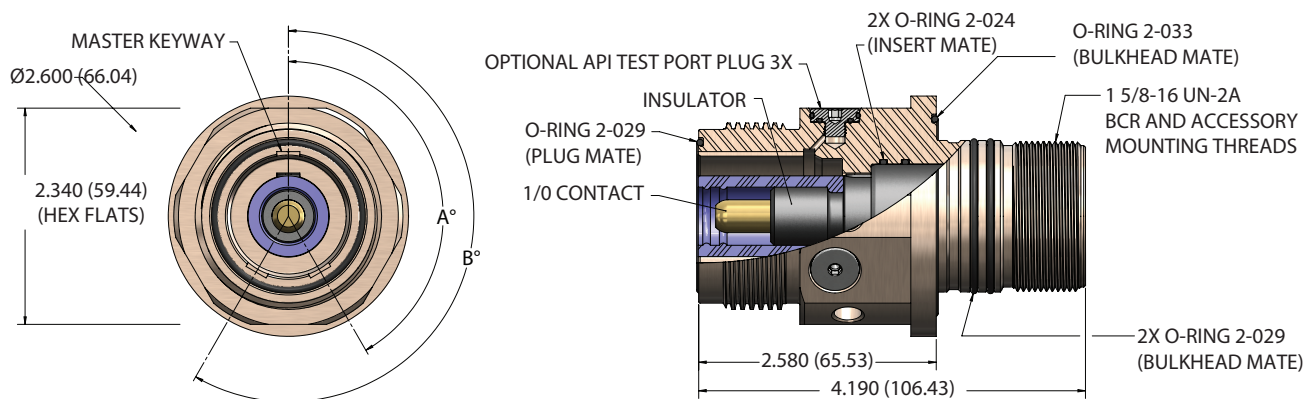



SERIES 700 SeaKing™ Power connectors for subsea primary power junctions



Size 64, 4-way #4/0 HV contact, 1kV, 350 amps/contact

How to Order SeaKing Power connectors			
Sample Part Number	707-0142	1	N
Series	707-0142 = SeaKing Power		
Connector Style	-1 = cable connector plug (CCP) -7 = bulkhead connector receptacle (BCR) -6 = flange connector receptacle (FCR)		
Key Position	N = normal, A, B, C; see key positions table		

Key Positions		
Position	A	B
N	150°	210°
A	75°	210°
B	95°	230°
C	140°	275°

707-0142-1 SEAKING POWER, CABLE CONNECTOR PLUG (CCP), SIZE 64, 4-WAY #4/0 HV CONTACTS

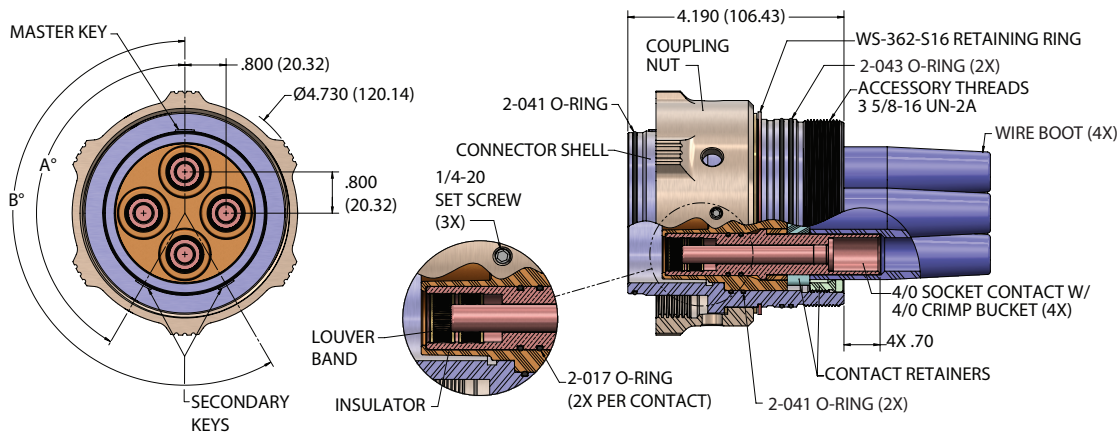

707-0142-7 SEAKING POWER, BULKHEAD CONNECTOR RECEPTACLE (BCR), SIZE 64, 4-WAY #4/0 HV CONTACTS

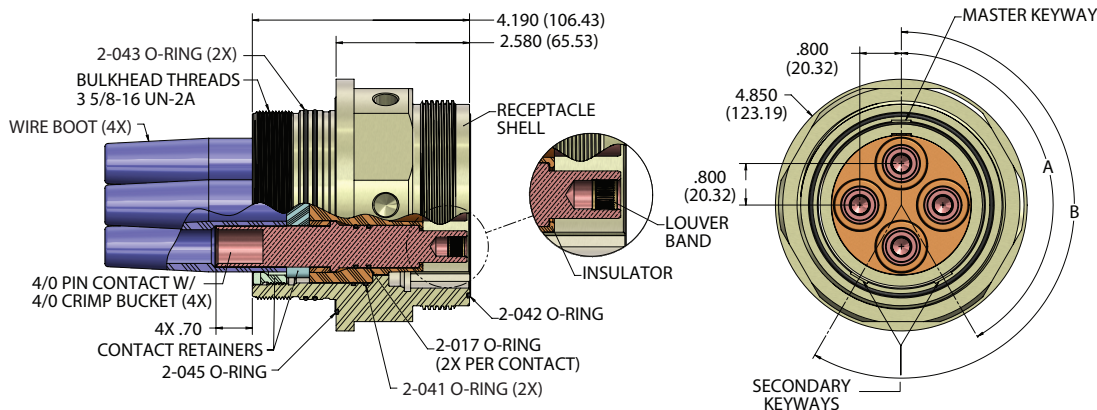



SERIES 700 SeaKing™ Power connectors for subsea primary power junctions



Size 64, 4-way #4/0 HV contact, 1kV, 350 amps/contact

How to Order SeaKing Power connectors			
Sample Part Number	707-0142	6	N
Series	707-0142 = SeaKing Power		
Connector Style	-1 = cable connector plug (CCP) -7 = bulkhead connector receptacle (BCR) -6 = flange connector receptacle (FCR)		
Key Position	N = normal, A, B, C; see key positions table		

Key Positions		
Position	A	B
N	150°	210°
A	75°	210°
B	95°	230°
C	140°	275°

707-0142-6 SEAKING POWER, FLANGE CONNECTOR RECEPTACLE (FCR), SIZE 64, 4-WAY #4/0 HV CONTACTS

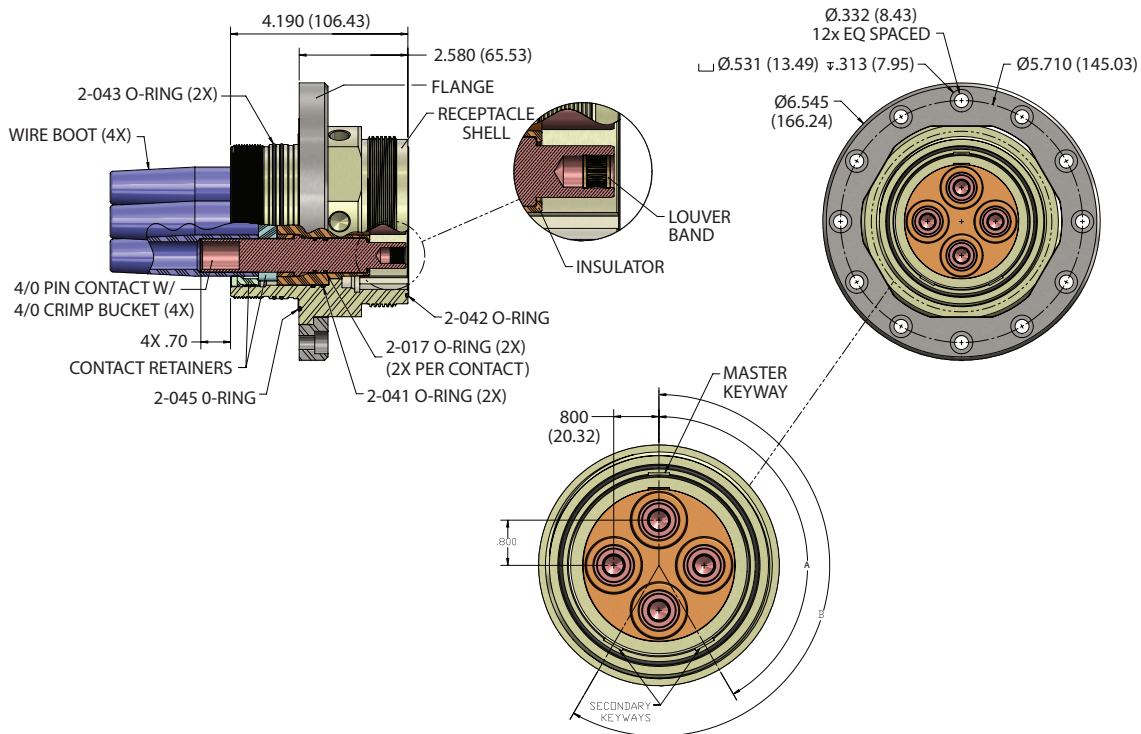



**DEEP
WATER**



Photo: NOAA



UNDERWATER 10K PSI DRY MATE ELECTRICAL SuperG55™

The SuperG55™ family of dry-mate underwater deep-sea-high pressure connectors are a revolutionary new design of the popular industry-standard used in countless ROV, underwater camera, diver communications, lights, pan and tilts, and other deep subsea applications.

Available in multiple shell sizes, the SuperG55™ is manufactured from 316L Stainless Steel with insert molded contact assemblies designed for pressure-sealed applications up to 10K psi mated and unmated. Intermateable and intermountable with other "55" series connectors, the Glenair solution introduces a long list of product innovations designed to improve performance and durability. Our PBOF versions, for example, utilize

easy-to-assemble threaded fittings which deliver both superior sealing performance while reducing installation time. Other innovations include full-mate inspection ports, improved solder cup contact design and more. Cable plugs and receptacles available in attachable (user-terminatable) versions as well as factory overmolded single-ended whips.

High-pressure open face bulkhead (BCR) and flange receptacles (FCR)

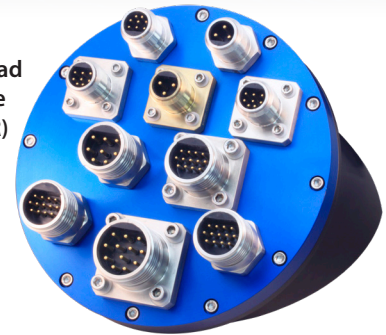

- 10,000 psi mated/unmated (approx. 22,500ft/7,000m)
- Recessed socket contacts in plugs for electrical safety
- Intermateable and intermountable with other "55" series connectors
- 4 shell sizes — 15, 20, 24 and 32 with 3 to 39 contacts
- PBOF versions available
- 600 VDC, 5 to 18 Amps (dependent on conductor and cable size and make-up)



Bulkhead Connector Receptacle (BCR)



Factory-terminated overmolded Cable Connector Plug (CCP)



Flange Connector Receptacle (FCR)



10K PSI / 700 BAR / 7000M SuperG55™ High-Pressure, Dry-Mate Underwater Connectors



Key mechanical and environmental features

SUPERG55™ PRESSURE-BALANCED OIL-FILLED CABLE CONNECTOR PLUG (CCP)

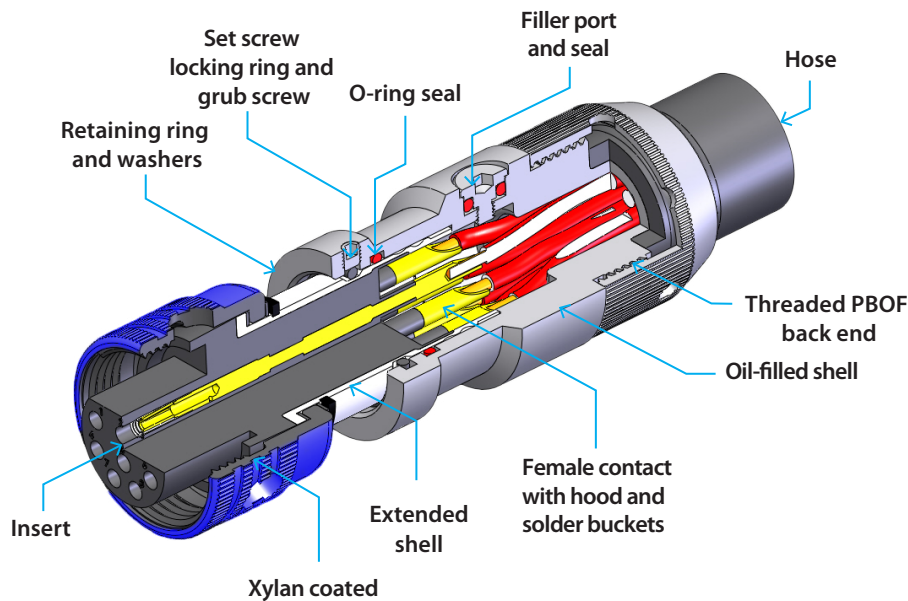

SuperG55™ Performance Specifications	
Mating Cycles	500
Pressure	689 Bar (10,000 PSI) Mated and Un-mated
Operating Temperature	-20°C to +90°C
Voltage Rating	600 Vdc / 440 Vac
Current (max.)	5 to 18 Amps (dependant on contact and cable conductor sizes)

SUPERG55™ FLANGE CONNECTOR RECEPTACLE (FCR)

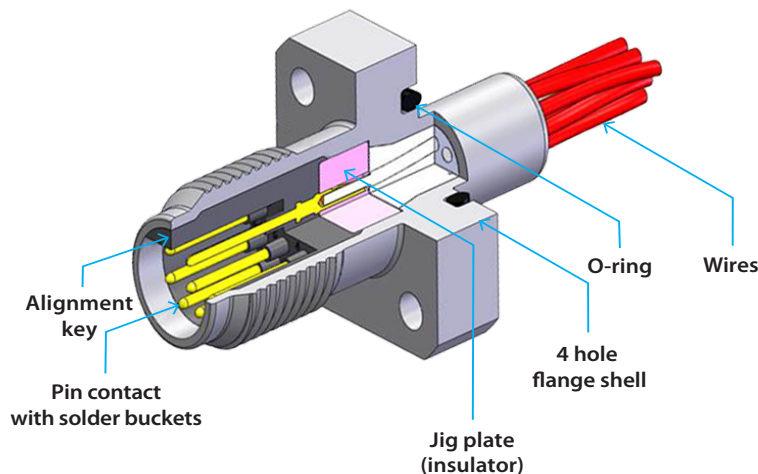

SuperG55™ Material/Finish	
Shells	316L Stainless Steel/ Passivated
Insulator	PEEK/NA
Insert	Neoprene/NA
Contacts	Copper Alloy/Gold Plated
O-rings	Nitrile/NA
Overmold and Cable	Polyurethane or Neoprene/NA
Coupling Nut	316L Stainless Steel/ Protective Coating Blue
Bulkhead Receptacle Tails	PTFE Insulated 16 AWG Wire/NA
Cable	Polyurethane or Neoprene Jacketed/NA

NON-STANDARD MATERIALS: Other material options are available as part of our non-catalog offerings including anodized aluminium, titanium, and aluminium bronze. Glenair is also able to supply SuperG55™ interconnects in composite thermoplastic (PEEK) to meet application requirements for reduced cathodic corrosion as well as weight reduction without affecting connector performance.

HIGH-SPEED ETHERNET: The SuperG55™ Ethernet option is available in the 1508, 2013 and 2021 contact configurations and provides both high speed (Up to 1GB) and power (600 Volts) in a full subsea environment (10,000 PSI). Gigabit speed data transfer up to a distance of 75mtrs.

Material Finish Codes			
Code	Material/Finish	Code	Material/Finish
	Anodized Aluminum	PK	Composite Thermoplastic (PEEK)
NAB2	Aluminum Bronze	B	Brass
T	Titanium	Alternative materials available, contact factory	



10K PSI / 700 BAR / 7000M SuperG55™ High-Pressure, Dry-Mate Subsea Connectors

Insert arrangements



SUPERG55™ INSERT ARRANGEMENTS Mating face view of pin insert (socket insert IDs are reversed)

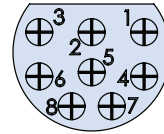
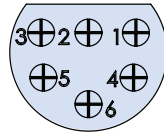
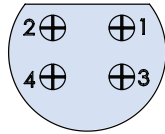
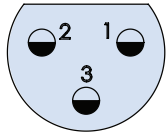

Shell Size 15

1503

3 Size #12 AWG
Contacts

1504

4 Size #16 AWG
Contacts

1506

6 size #16 AWG
Contacts

1508*

8 size #16 AWG
Contacts

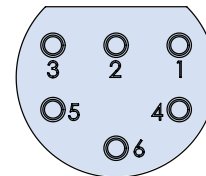
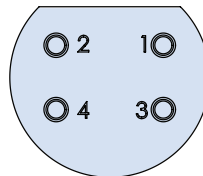
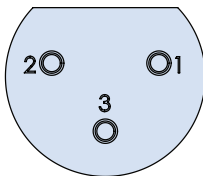

Shell Size 20

2003

3 Size #10 AWG
Contacts

2004

4 Size #10 AWG
Contacts

2006

6 Size #10 AWG
Contacts

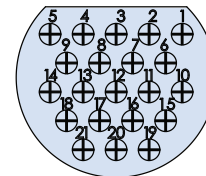
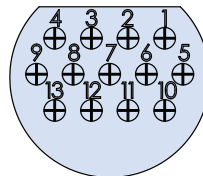
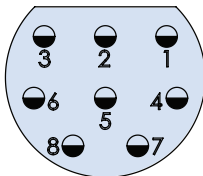

Shell Size 20

2008*

8 Size #12 AWG
Contacts

2013*

13 Size #16 AWG
Contacts

2021*

21 Size #16 AWG
Contacts

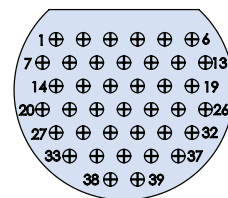
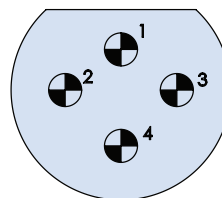
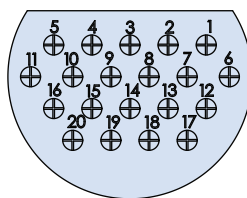
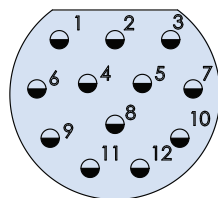

Shell Size 24

2412

12 Size #12 AWG
Contacts

2420

20 Size #16 AWG
Contacts

Shell Size 32

3204**

4 Size #6 AWG
Contacts

3239**

39 Size #16 AWG
Contacts

Bulkhead Mounting
Torque
(Values are for dry
non-lubricated threads)

Size 15 - 14.12NM (125LB.INS.)
Size 20 - 18.64NM (165LB.INS.)
Size 24 - 25.42NM (225LB.INS.)
Size 32 - TBD

*Compatible with high-speed Ethernet
**Size 3204 and 3239 are not interchangeable
with any other brand of connector

Custom insert arrangements available,
contact factory.



10K PSI / 700 BAR / 7000M
**SuperG55™ High-Pressure,
 Dry-Mate Subsea Connectors**
 Super G55 Series connectors



G55 A1 ATTACHABLE CABLE CONNECTOR PLUG (CCP)



SuperG55™ - How To Order	
Sample Part Number	G55A1 -1508 -0000
Series	SuperG55™ = underwater dry-mate, long version (CCP), attachable
Shell Size/Insert Arrangement Size	See shell size / insert arrangements (page 38)
Overall Length	In feet (0000 = no cable, 0001 = one foot, etc.)
Potting Boot	PB = potting boot; omit for none. Not required if used for OFR1
Material Option	Omit for stainless steel B = brass coupling nut and barrel PK = peek coupling nut and barrel See material options on page 37

G55 01 STRAIGHT OVERMOLDED, CABLE PLUG (CCP)



SuperG55™ - How To Order	
Sample Part Number	G5501 -1508 -0004
Series	SuperG55™ = underwater dry-mate, straight overmolded CCP
Shell Size/Insert Arrangement	See shell size / insert arrangements (page 38)
Cable Length	In feet (0001 = one foot, 0002 = two feet etc.)
Inch Increments	3, 6 or 9 inches; omit for whole feet lengths
Material Option	Omit for stainless steel B = brass coupling nut and barrel PK = peek coupling nut and barrel See material options on page 37
Back-to-Back	B2B = back-to-back; omit if not required

G55 R1 RIGHT ANGLE OVERMOLDED, CABLE CONNECTOR PLUG (CCP)



SuperG55™ - How To Order	
Sample Part Number	G55R1 -1508 -0004
Series	SuperG55™ = underwater dry-mate, right angle overmolded CCP
Shell Size/Insert Arrangement	See shell size / insert arrangements (page 38)
Cable Length	In feet (0001 = one foot, 0002 = two feet etc.)
Inch Increments	3, 6 or 9 inches; omit for whole feet lengths
Material Option	Omit for stainless steel B = brass coupling nut and barrel PK = peek coupling nut and barrel See material options on page 37
Back-to-Back	B2B = back-to-back; omit if not required



10K PSI / 700 BAR / 7000M
**SuperG55™ High-Pressure,
 Dry-Mate Subsea Connectors**
 Super G55 Series connectors



G55 OF1 STRAIGHT OIL-FILLED CABLE CONNECTOR PLUG (CCP)



SuperG55™ - How To Order				
Sample Part Number	G55OF1	-1508	-0010	
Series	SuperG55™ = Underwater dry-mate, straight oil-filled CCP			
Shell Size/Insert Arrangement	See shell size / insert arrangements (page 38)			
Overall Length	In feet (0000 = no cable, no hose 0001 = one foot, etc.)			
Back-to-Back*	B2B = back-to-back (min. 7ft hose length); omit if not required			

*Consult factory for additional back-to-back options

G55 OFR1 RIGHT ANGLE OIL-FILLED, CABLE CONNECTOR PLUG (CCP)



SuperG55™ - How To Order				
Sample Part Number	G55OFR1	-1508	-0010	
Series	SuperG55™ = Underwater dry-mate, right angle oil-filled CCP			
Shell Size/Insert Arrangement	See shell size / insert arrangements (page 38)			
Overall Length	In feet (0000 = no cable, no hose 0001 = one foot, etc.)			
Back-to-Back*	B2B = back-to-back (min. 7ft hose length); omit if not required			

*Consult factory for additional back-to-back options

G55 06 FLANGE CONNECTOR RECEPTACLE (FCR)



SuperG55™ - How To Order				
Sample Part Number	G5506	-2013	-0004	
Series	SuperG55™ = underwater dry-mate, flange connector receptacle (FCR)			
Shell Size/Insert Arrangement	See shell size / insert arrangements (page 38)			
Cable Length	In feet (0001 = 1 foot, 0004 = 4 feet, standard length)			
Material Option	Omit for stainless steel B = brass coupling nut and barrel	PK = peek coupling nut and barrel See material options on page 37		



10K PSI / 700 BAR / 7000M
**SuperG55™ High-Pressure,
 Dry-Mate Subsea Connectors**
 Super G55 Series connectors



G55 07 BULKHEAD CONNECTOR RECEPTACLE (BCR)



SuperG55™ - How To Order				
Sample Part Number	G5507	-1508	-0004	
Series	SuperG55™ = underwater dry-mate, bulkhead connector receptacle (BCR)			
Shell Size/Insert Arrangement	See shell size / insert arrangements (page 38)			
Cable Length	In feet (0001 = 1 foot, 0004 = 4 feet, standard length)			
Material Option	Omit for stainless steel B = brass coupling nut and barrel		PK = peek coupling nut and barrel See material options on page 37	

G55 A2 ATTACHABLE CABLE CONNECTOR RECEPTACLE (CCR)

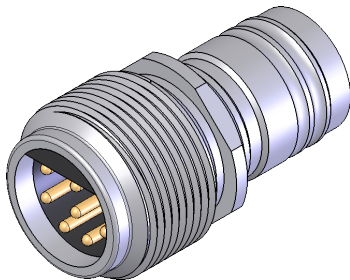

SuperG55™ - How To Order				
Sample Part Number	G55A2	-1508	-0000	
Series	SuperG55™ = underwater dry-mate, attachable cable connector receptacle (CCR)			
Shell Size/Insert Arrangement	See shell size / insert arrangements (page 38)			
Cable Length	In feet (0000 = no cable, 0001 = one foot, etc.)			
Material Option	Omit for stainless steel B = brass coupling nut and barrel		PK = peek coupling nut and barrel See material options on page 37	

*Currently only 1504, 1506, 1508, 2013, 2021 & 2420 insert arrangements are available.

G55 02 STRAIGHT OVERMOLDED, CABLE CONNECTOR RECEPTACLE (CCR)



SuperG55™ - How To Order					
Sample Part Number	G5502	-1508	-0004		
Series	SuperG55™ = underwater dry-mate, straight overmolded CCR				
Shell Size/Insert Arrangement	See shell size / insert arrangements (page 38)				
Cable Length	In feet (0001 = one foot, 0002 = two feet etc.)				
Inch Increments	3, 6 or 9 inches; omit for whole feet lengths				
Material Option	Omit for stainless steel B = brass coupling nut and barrel		PK = peek coupling nut and barrel See material options on page 37		
Back-to-Back	B2B = back-to-back; omit if not required				



10K PSI / 700 BAR / 7000M
**SuperG55™ High-Pressure,
 Dry-Mate Subsea Connectors**
 Super G55 Series connectors



G55 R2 RIGHT ANGLE OVERMOLDED CABLE CONNECTOR RECEPTACLE (CCR)



SuperG55™ - How To Order				
Sample Part Number	G55R2	-1508	-0004	
Series	SuperG55™ = underwater dry-mate, right angle overmolded CCR			
Shell Size/Insert Arrangement	See shell size / insert arrangements (page 38)			
Cable Length	In feet (0001 = one foot, 0002 = two feet etc.)			
Inch Increments	3, 6 or 9 inches; omit for whole feet lengths			
Material Option	Omit for stainless steel B = brass coupling nut and barrel		PK = peek coupling nut and barrel See material options on page 37	
Back-to-Back	B2B = back-to-back; omit if not required			

G55 OF2 STRAIGHT OIL-FILLED CABLE CONNECTOR RECEPTACLE (CCR)



SuperG55™ - How To Order				
Sample Part Number	G55OF2	-1508	-0010	
Series	SuperG55™ = Underwater dry-mate, straight oil-filled CCR			
Shell Size/Insert Arrangement*	See shell size / insert arrangements (page 38)			
Overall Length	In feet (0000 = no cable, no hose, 0001 = one foot, etc.)			
Back-to-Back**	B2B = back-to-back (min. 7ft hose length); omit if not required			

*Currently only 1504, 1506, 1508, 2013, 2021, and 2420 insert arrangements are available
 **Consult factory for additional back-to-back options

G55 OFR2 RIGHT ANGLE OIL-FILLED CABLE CONNECTOR RECEPTACLE (CCR)



SuperG55™ - How To Order				
Sample Part Number	G55OFR2	-1508	-0010	
Series	SuperG55™ = Underwater dry-mate, right angle oil-filled CCR			
Shell Size/Insert Arrangement*	See shell size / insert arrangements (page 38)			
Overall Length	In feet (0000 = no cable, no hose, 0001 = one foot, etc.)			
Back-to-Back*	B2B = back-to-back (min. 7ft hose length); omit if not required			

*Currently only 1504, 1506, 1508, 2013, 2021, and 2420 insert arrangements are available
 **Consult factory for additional back-to-back options



10K PSI / 700 BAR / 7000M
**SuperG55™ High-Pressure,
 Dry-Mate Subsea Connectors**
 Super G55 Series connectors



G55 D1 DUMMY SEALING PLUG (DSP)



SuperG55™ - How To Order				
Sample Part Number	G55D1	-1508	-0000	
Series	SuperG55™ = dummy sealing plug (DSP)			
Shell Size/Insert Arrangement	See shell size / insert arrangements (page 38)			
Cable Length	0000 = no cable			
Material Option	Omit for stainless steel B = brass coupling nut and barrel		PK = peek coupling nut and barrel See material options on page 37	

G55 D2 DUMMY SEALING RECEPTACLE (DSR)

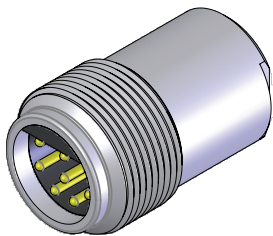

SuperG55™ - How To Order				
Sample Part Number	G55D2	-1508	-0000	
Series	SuperG55™ = dummy sealing receptacle (DSR)			
Shell Size/Insert Arrangement	See shell size / insert arrangements (page 38)			
Cable Length	0000 = no cable			
Material Option	Omit for stainless steel B = brass coupling nut and barrel		PK = peek coupling nut and barrel See material options on page 37	

G55 M1 SOCKET TO SOCKET (CCP)

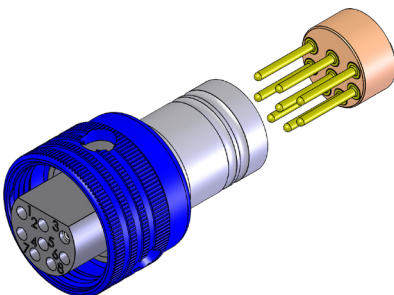

SuperG55™ - How To Order				
Sample Part Number	G55M1	-1508	-0001	
Series	SuperG55™ = underwater dry-mate, back-to-back socket CCP			
Shell Size/Insert Arrangement	See shell size / insert arrangements (page 38)			
Cable Length	In feet (0000 = no cable, 0001 = one foot, etc.)			
Material Option	Omit for stainless steel B = brass coupling nut and barrel		PK = peek coupling nut and barrel See material options on page 37	



10K PSI / 700 BAR / 7000M

SuperG55™ High-Pressure, Dry-Mate Subsea Connectors



Super G55 Series custom connectors

G55 06 FLANGE CONNECTOR RECEPTACLE (FCR) WITH EARTH LEAD

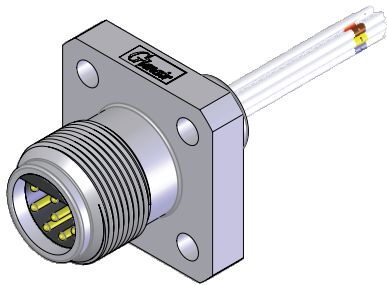

SuperG55™ - How To Order					
Sample Part Number	G5506	-1508	-0004	-EL	
Series	SuperG55™ = underwater dry-mate, FCR with earth lead				
Shell Size/Insert Arrangement	See shell size / insert arrangements (page 38)				
Cable Length	In feet (0001 = 1 foot, 0004 = 4 feet, standard length)				
Earth Lead	EL = earth lead (ground)				
Material Option	T = titanium; omit for stainless steel				

G55 07 BULKHEAD CONNECTOR RECEPTACLE (BCR) WITH EARTH LEAD

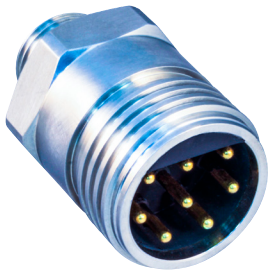

SuperG55™ - How To Order					
Sample Part Number	G5507	-1508	-0004	-EL	
Series	SuperG55™ = underwater dry-mate, BCR with earth lead				
Shell Size/Insert Arrangement	See shell size / insert arrangements (page 38)				
Cable Length	In feet (0001 = 1 foot, 0004 = 4 feet, standard length)				
Earthing Lead	EL = earth lead (ground)				
Material Option	T = titanium; omit for stainless steel				

G55 06IF FLANGE CONNECTOR RECEPTACLE (FCR) WITH INDEXABLE FLANGE



SuperG55™ - How To Order					
Sample Part Number	G5506IF	-1508	-0004		
Series	SuperG55™ = underwater dry-mate, flange connector receptacle (FCR) with indexable flange				
Shell Size/Insert Arrangement	See shell size / insert arrangements (page 38)				
Cable Length	In feet (0001 = 1 foot, 0004 = 4 feet, standard length)				
Material Option	Omit for stainless steel B = brass coupling nut and barrel		PK = peek coupling nut and barrel See material options on page 37		



10K PSI / 700 BAR / 7000M SuperG66™ High-Pressure, Dry-Mate Subsea Connectors



COMING SOON: Super G66 reverse-gender connectors

G66 OVERMOLDED CABLE CONNECTOR PLUGS AND RECEPTACLES

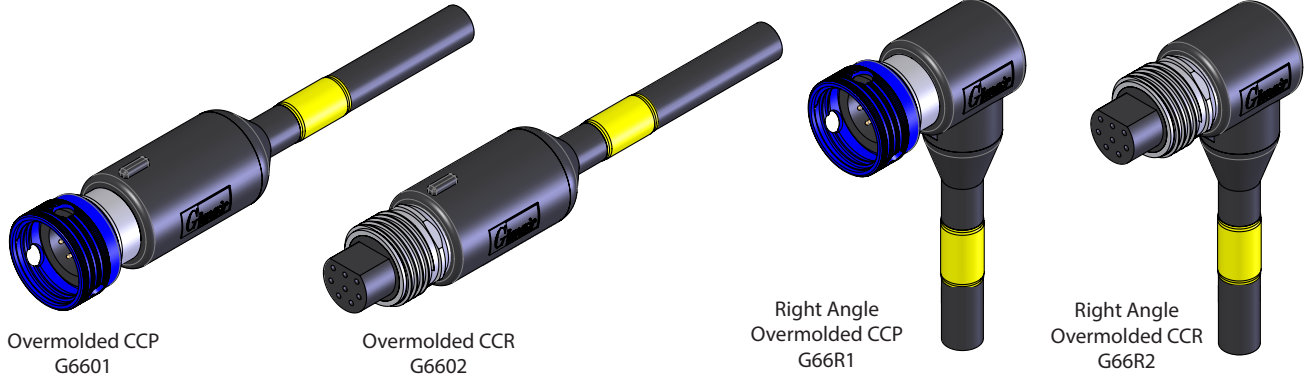

G66 OIL-FILLED CABLE CONNECTOR PLUGS AND RECEPTACLES

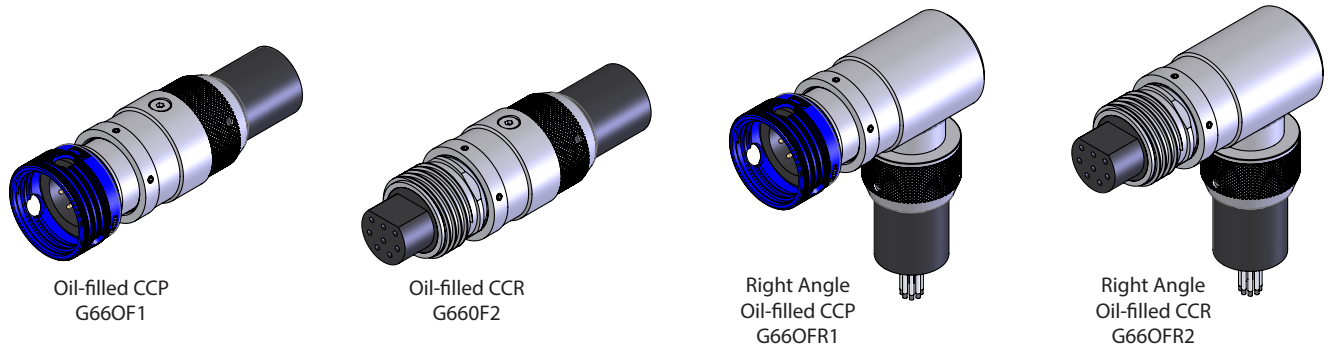

G66 CABLE CONNECTOR PLUGS AND BULKHEAD, FLANGE AND CABLE CONNECTOR RECEPTACLES

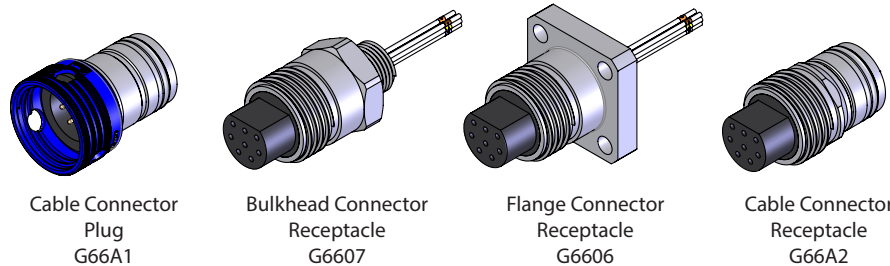

DUMMY SEALING PLUG AND RECEPTACLE

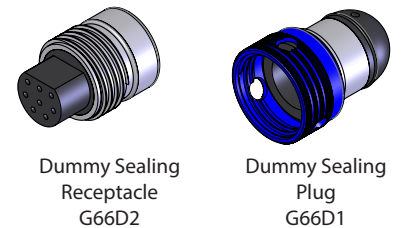

COMING SOON: SuperG66™ - Consult factory for availability				
Sample Part Number	G66A1	-2008	-0000	
Series	SuperG66™ = underwater dry-mate, cable connector plug (CCP)			
Shell Size/Insert Arrangement	See shell size / insert arrangements (page 38)			
Cable Length	0000 = no cable; also available in specified lengths for test purposes			
Material Option	Omit for stainless steel PK = peek coupling nut and barrel B = brass coupling nut and barrel Reference material options on page 37			
Potting Boot	PB = potting boot; omit if not required. Not required if changed to OFR1			

INSERT ARRANGEMENTS

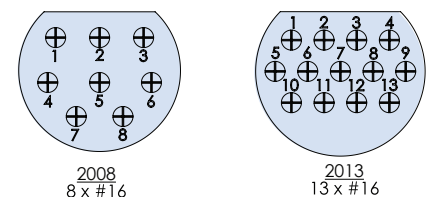

Additional insert arrangements can be engineered, contact factory

Series 707 Micro-PSI affords PIG designers the opportunity to design out legacy large form-factor connectors (such as shown in this picture) with a dramatically smaller interconnect solution.

SERIES 707

Micro-PSI

Microminiature high-pressure connectors and cables

The Series 707 Micro-PSI is an ultraminiaturized 10K psi high-pressure, high-temperature interconnect designed specifically for pipeline inspection applications in Magnetic Flux Leakage and ultrasonic pipeline inspection PIGs. The Micro-PSI insert arrangements feature two high-density micro TwistPin layouts for sensor applications and high-speed Gigabit Ethernet, and a Coax contact layout for 5 GHz performance. Micro-PSI connectors are supplied as discrete plugs, or overmolded plug cordsets with rugged Viton or Polyurethane jacketing. Jam-nut and panel-mount receptacles are 10K psi open-face pressure sealed, and incorporate fused vitreous glass inserts for $<1 \times 10^{-7}$ scc He/sec hermetic performance. Serviceable O-rings on plugs and dual piston and face O-rings on receptacles provide high-reliability sealing.

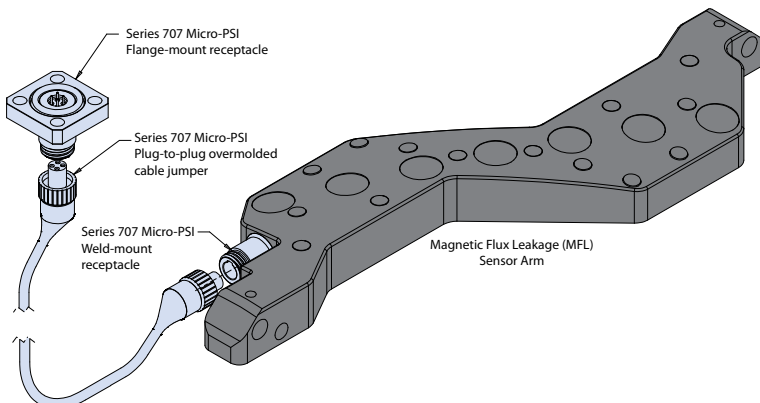

Application example shows the 707 Micro-PSI used to interconnect an MFL sensor to on-board PIG data storage.



- Special-purpose high density (.050" contact spacing) intelligent inspection (PIG) connector series
- 3 Amp high-speed Gigabit Ethernet-ready
- -20° to +150°C temperature range
- High-density, small form-factor

INSERT ARRANGEMENTS

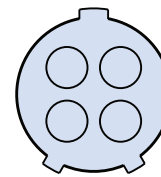

E4 Layout
4 Micro Contacts

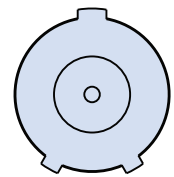

E1 Layout
50 Ohm Coax

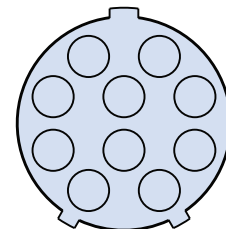

G10 Layout
10 Micro Contacts
High-Speed Ethernet



SERIES 707 Micro-PSI



Microminiature, high-pressure Specifications and insert arrangements

MICRO PSI HOW TO ORDER, SPECIFICATIONS, MATERIALS AND FINISHES

Micro-PSI - How To Order					
Sample Part Number	707-0148	-E4	-Z1	S	N
Series / Connector Style	707-0148 = Receptacle, Square Flange 707-0172 = Receptacle, Jam-Nut Mount 707-0171 = Plug				
Shell Size/Insert Arrangement	E1, E4, E10				
Shell Material	Z1 = Stainless Steel TC = Titanium				
Contact Type (Based on Shell Style Type)	Plug (707-0171) Receptacle (707-0148 & 707-0172) P = Pin S = Socket Contacts / Solderpots F = Socket Contacts / Flying Leads D = Socket Contacts / PCB Terminals				
Locking Position	N = Normal, A, B, C (see Key and Keyway Positions table below)				

- 10K psi open-face and mated condition sealing
- Fail-safe piston and mounting face O-rings
- Alignment and full-mate indicators
- 150°C continuous operating temperature range, 200° C options available, consult factory

For single-ended cable with overmolded plug (7071-0069), contact factory for How-to-Order information.

Performance Specifications	
Hydrostatic Pressure	10,000 PSI (mated)
DWV	200 VAC per EIA-364-20
Insulation Resistance	5000 Megohms at 500 Vdc per EIA-364-21
Operating Temperature	-20°C to +150°C 200°C options available consult factory

MicroPSI Key and Keyway Positions				
Key Position	Key Rotation		Plug	Receptacle
	X°	Y°		
Normal (N)	150°	210°		
A	75°	210°		
B	95°	230°		
C	140°	275°		

Material and Finish	
Shell, Coupling Ring/Retaining Ring	See Part Number Development
Contacts	Plug: Copper alloy, gold plated. Receptacle: Iron alloy, gold plated
Cable Jacket and Plug Overmold	Composite See Part Number
Insulator	Thermoplastic
O-rings	Viton 90 durometer
Hermetic Seal	Glass

NOTES

- Plug connectors typically supplied as prewired factory cable assemblies with Viton® overmolding for caustic chemical resistance
- Receptacle connectors commonly supplied as prewired pigtails or flex jumpers for direct connection to printed circuit boards and / or data drives
- High-speed Ethernet up to 1Gbps

MICRO-PSI ELECTRICAL PERFORMANCE AT OPERATING TEMPERATURE -20°C TO +150°C

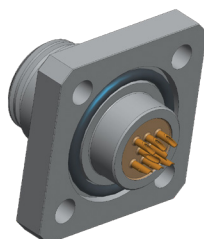
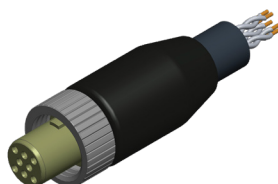

- 3 Amps per line
- Supports #24AWG water-blocked twisted pair wiring
- Dielectric Withstanding Voltage: 600 VAC
- Insulation Resistance: 5000 megohms at 500VDC



SERIES 707 Micro-PSI



Microminiature, high-pressure connectors and cables

707-0171 MICRO-PSI PLUG

- 10K psi rated, mated condition
- Red alignment indicator for accurate mating
- Serviceable O-ring for reliable sealing and easy maintenance
- Ultra small form-factor

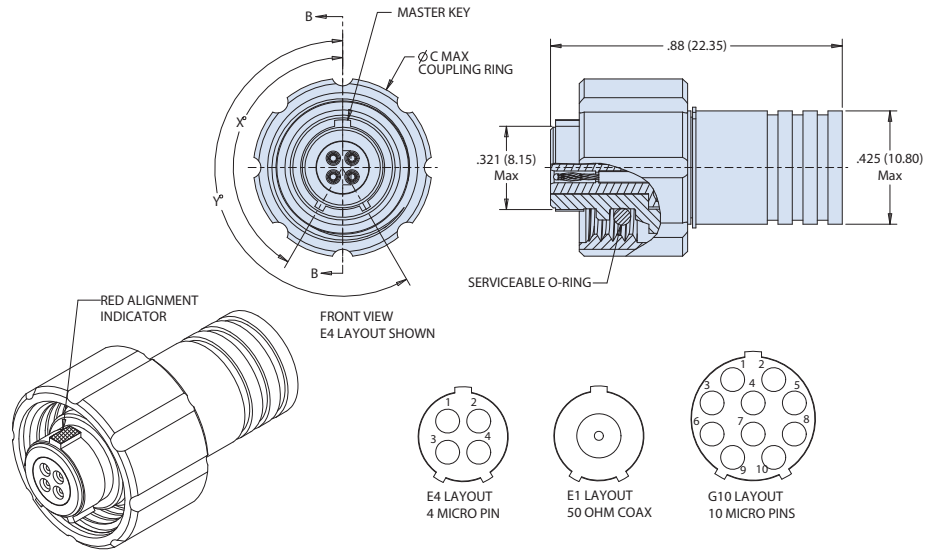

707-0172 MICRO-PSI JAM-NUT MOUNT RECEPTACLE

- 10K psi open-face rated
- Vitreous glass sealed, $<1 \times 10^{-7}$ scc He/sec hermeticity
- Operating temperature -20° to $+200^{\circ}\text{C}$
- Fail-safe piston and mounting face O-rings
- Alignment and full-mate indicators
- Ultra small form-factor

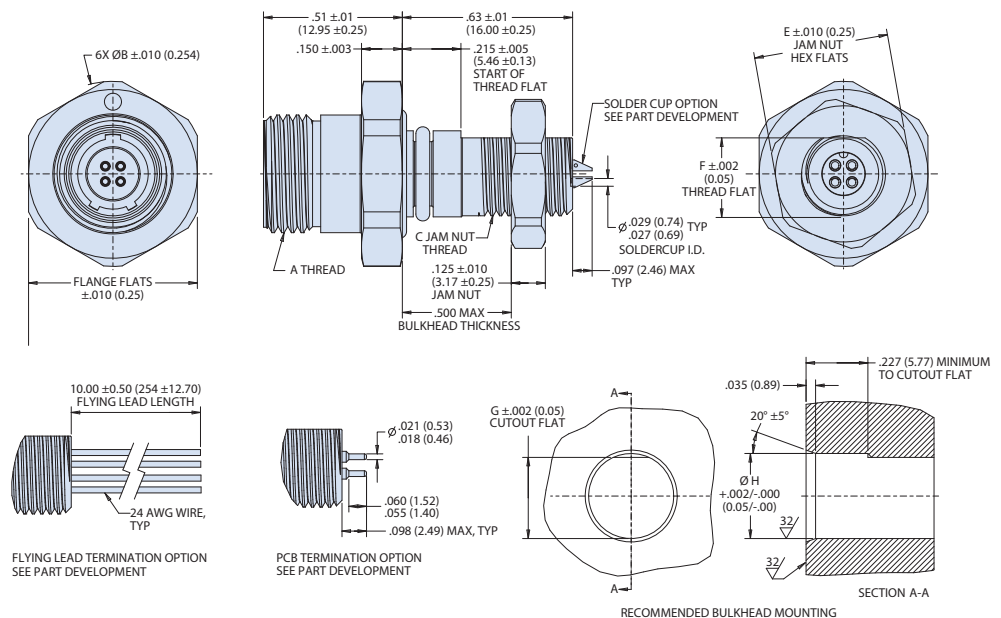



SERIES 707 Micro-PSI



Microminiature, high-pressure connectors and cables

707-0148 MICRO-PSI PANEL MOUNT RECEPTACLE

- 10K psi open-face rated
- Vitreous glass sealed, <math><1 \times 10^{-7}</math> scc He/sec hermeticity
- Operating temperature -20° to +200° C
- Fail-safe piston and mounting face O-rings
- Alignment and full-mate indicators
- Ultra small form-factor

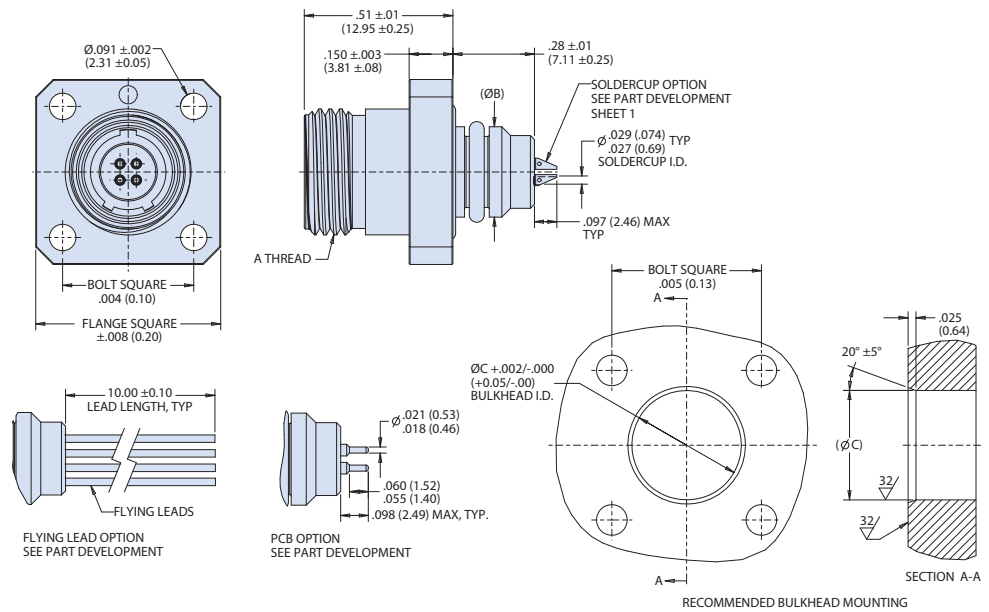

707-0069 MICRO-PSI OVERMOLDED CABLE PLUG

- 10K psi rated, mated condition
- Rugged Viton or Polyurethane overmold and cable jacket
- Operating temperature -20° to +200° C
- Ultra small form-factor

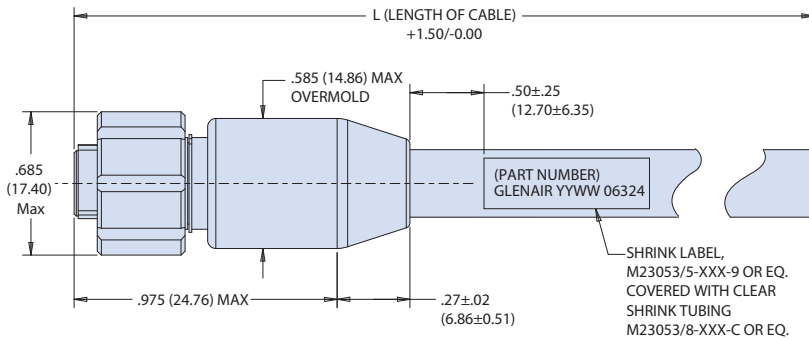

Contact factory for order information

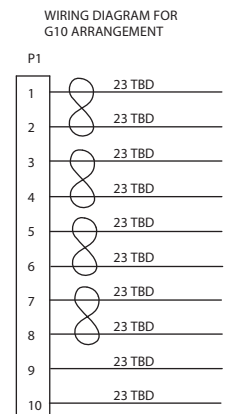
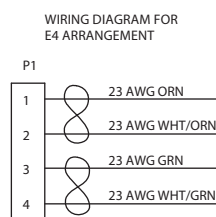
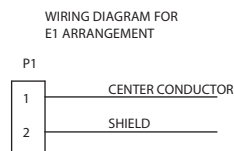



SERIES 802

AquaMouse

Ultraminiature 3500 PSI

Originally developed for petroleum pipeline inspection equipment, Series 802 connectors are available in ten sizes from 1 to 130 contacts and equipped with Viton® O-rings to withstand exposure to corrosive chemicals and high temperature environments. These connectors feature high density crimp Mighty Mouse inserts, 316 stainless steel or marine bronze shells and a piston O-ring for hydrostatic sealing. Series 802 insulated wire, panel mount receptacles can be ordered as square flange, in-line or jam-nut versions. Choose integral shield termination platform or accessory thread for use with a variety of strain relief options. Crimp style gold-plated crimp contacts accept #12–30 wire. Connectors are backfilled with epoxy potting compound. Hermetic glass-sealed connectors come with solder cup contacts (non-removable) or PC tails. 100% tested to meet 1×10^{-7} cc/sec helium leakage. Open face pressure rating 3500 PSI.

- 3500 psi pressure rated
- High-temperature and corrosive chemical-resistant Viton® or Nitrile O-rings
- Ultraminiature #23 contacts
- Size #20, #20HD, #16, #12, #8 signal, power, fiber optic and shielded contacts
- Discrete connectors and turnkey cable assemblies

AQUAMOUSE CONNECTOR CONFIGURATIONS AND CLASSES



Series 802 Plugs



Series 802
Jam Nut Mount



Series 802
Square Flange Receptacle

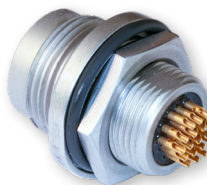

Series 802
Hermetic



Series 802 Hermetic
Bulkhead Feed-Thru



SERIES 802 2400M / 3500 PSI
Ultraminiature Harsh-Environment Connectors
 Series 802 AquaMouse™ Performance specifications and material and finish

Glenair Series 802 AquaMouse™ Delivers High-Pressure Sealing and Rugged Design in a Miniature Package

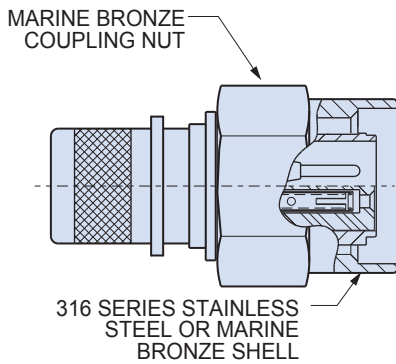

Series 802 Plug

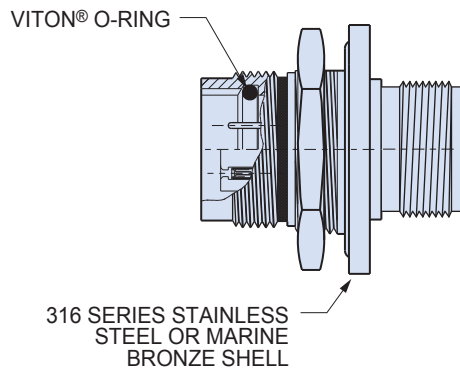

Series 802 Receptacle

Stainless Steel or Marine Bronze

Available in ten sizes from 1 to 130 contacts, Series 802 connectors feature 316 stainless steel or marine bronze shells. Viton® o-rings resist high temperature and corrosive chemicals.

3500 psi

These connectors withstand up to 3500 PSI hydrostatic pressure in a mated condition. Hermetic versions withstand 1000 PSI open face pressure.

AQUAMOUSE SPECIFICATIONS AND PLUG KEY POSITIONS

Series 802 Plug Key Positions		
Key Position	Key Rotation	
	A°	B°
Normal (A)	150°	210°
B	75°	210°
C	95°	230°
D	140°	275°
E	75°	275°
F	9°	210°

Performance Specifications	
Current Rating	#23-5 A, #20-7.5 A, #16-13 A, #12-23 A
Dielectric Withstanding Voltage	#23-750 VAC, #20HD-1000VAC, #16 and #12-1800 VAC
Insulation Resistance	5000 megohms minimum
Operating Temperature	-65° C. to +175° C.
Hydrostatic Pressure	3500 PSI mated, 1000 PSI open face (hermetic)
Shock	300 g.
Vibration	37 g.
Durability	2000 mating cycles

Material and Finish	
Shells, Jam Nuts	316 stainless steel or marine bronze
Coupling Nuts	Marine bronze, unplated
Contacts	Copper alloy, 50 µlnch gold plated. Socket hood: stainless steel, passivated. Hermetic pin contacts: Nickel-Iron alloy per ASTM-F-30, 50 µlnch gold plated.
Insulators	Liquid crystal polymer (LCP) , 30% glass-filled
Contact Retention Clip	Beryllium copper alloy
Interfacial Seal, O-rings	Viton Rubber
Interfacial seal, rear grommet	Fluorosilicone rubber, blue
O-rings	Viton®



SERIES 22

Geo-Marine®

High-pressure harsh-environment connectors and overmolded cables for inspection pigs and other high-pressure/high-temp applications

Designed for use in oceanographic, geophysical and other severe industrial environments, Glenair Series 22 Geo-Marine® Connectors and Cables are the ultimate harsh-environment power and signal connector solution. Built to withstand hydrostatic pressures up to 5,000 PSI and exposure to extreme temperatures and corrosives, the Series 22 Geo-Marine® is ideally suited for applications such as intelligent pipeline inspection, towed array sonar systems, submersibles and ROVs, offshore oil drilling equipment, seabed exploration, well monitoring equipment, and digital seismic streamers.

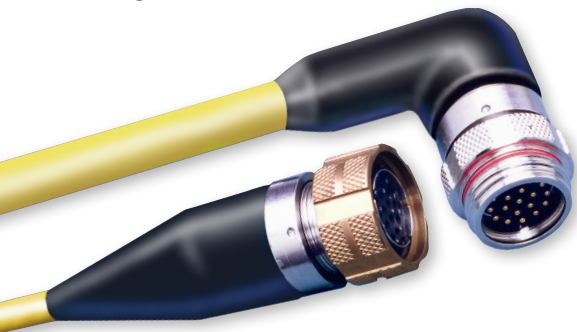

Geo-Marine® plugs are equipped with arctic coupling nuts—made from marine-grade naval bronze—with easy-to-grip castellated knurling and a powerful ratcheted anti-decoupling mechanism which guarantees reliable mating and demating performance in even the harshest environments. Supplied as discrete connectors—or more typically in build-to-print overmolded cable assemblies.



Geo-Marine®

- **5000 psi pressure rated**
- **Marine Grade 316 stainless steel machined shells and Naval Bronze coupling rings**
- **High-pressure environmental and hermetically sealed receptacles for field applications**
- **Power and signal insert arrangements from 2 to 128 contacts**
- **Anti-vibration ratcheted coupling nuts with castellated knurling**
- **Available Viton® overmolded cable assemblies**



SERIES 22 Geo-Marine® Connectors



High-pressure environmental and fused-glass connectors



Range of Offerings

Series 22 Geo-Marine® connectors are supplied with either fused-glass or high grade thermoplastic insulators. Both classes of connectors are supplied with rugged, corrosion-resistant materials. Low-profile and scoop-proof cable plugs and receptacles, as well as bulkhead feed-thrus are available. Specially-designed cable sealing backshells as well as EMI/RFI shield termination backshells and environmentally-sealed protective covers complete the range of discrete product offerings. 35 insert arrangements (contact sizes #12, #16, #20 and #22) are tooled and fully available. Special in-line single-pin HTHP glass fused contacts also available.

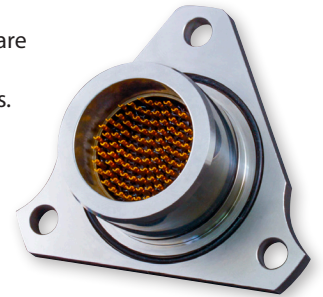

WIDE RANGE OF PLUG CONFIGURATIONS WITH ANTI-GALLING ARCTIC COUPLING NUTS



Cable plug with accessory threads



Cable plug with overmold adapter



Panel-mounted plug

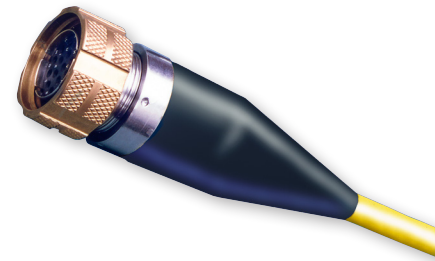

Factory overmolded plug

HIGH-PRESSURE ENVIRONMENTAL AND FUSED-GLASS RECEPTACLE CONFIGURATIONS



Jam Nut



In-Line

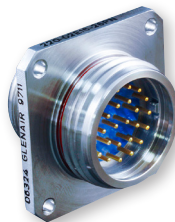

Square Flange



Solder-Mount



Bulkhead Feed-Thru



Single-pin HTHP

RUGGEDIZED STAINLESS STEEL BACKSHELLS AND OTHER CONNECTOR ACCESSORIES



Environmental strain relief backshell



Overmolding adapter



Right-angle strain relief backshell



Environmentally sealed protective covers



SERIES 22 Geo-Marine® Connectors



High-pressure environmental and fused-glass connectors

Performance Specifications			
Hydrostatic Pressure Rating:	5,000 PSI (fully mated)		
Operating Temperature:	-65°C to +125°C		
Durability:	500 Cycles of mate/demate		
Insulation Resistance:	1000 Megohms minimum at 500 VDC		
Class H Hermetic Receptacles			
Open-Face Pressure Rating	1,000 to 5,000 PSI		
Hermeticity	Less than 1 X 10 ⁻⁶ sccHe/second @ 1 atmosphere		
Current Rating			
Current Rating	Environmental	Hermetic	
Size 22 Contact	500 VDC, 5 amps	500 VDC, 3 amps	
Size 20 Contact	500 VDC, 7.5 amps	500 VDC, 5 amps	
Size 16 Contact	750 VDC, 13 amps	750 VDC, 10 amps	
Size 12 Contact	750 VDC, 23 amps	750 VDC, 17 amps	
Service Rating			
Contact Size	Suggested Operational Voltage (Sea Level)		Test Voltage (Sea Level)
	AC(RMS)	DC	
22 GA	400	550	1300 VDC
20 GA	600	850	1800 VDC
16 GA	900	1250	2300 VDC
12 GA	300	450	2300 VDC

Depth/Pressure Conversion							
Feet	Meters	P.S.I.	Bar	Feet	Meters	P.S.I.	Bar
1	.3	.4	.0296	1,000	304.8	433.0	29.8543
10	3.1	4.3	.2965	1,500	457.2	649.5	44.7814
50	15.2	21.7	1.4962	2,500	762.0	1082.5	74.6357
100	30.5	43.3	2.9854	5,000	1524.0	2165.0	149.2715
250	76.2	108.3	7.4670	10,000	3048.0	4330.0	298.5430
500	152.4	216.5	14.9271	11,547	3519.35	5000.0	344.7379

Cable/Wire D.C. Resistance			
Copper Conductors at Room Temperature			
AWG	Ohms per 1000 feet	AWG	Ohms per 1000 feet
28	66.2 Max	20	10.4 Max
26	41.6 Max	18	6.5 Max
24	26.2 Max	16	4.1 Max
22	16.5 Max	14	2.6 Max
		12	1.6 Max

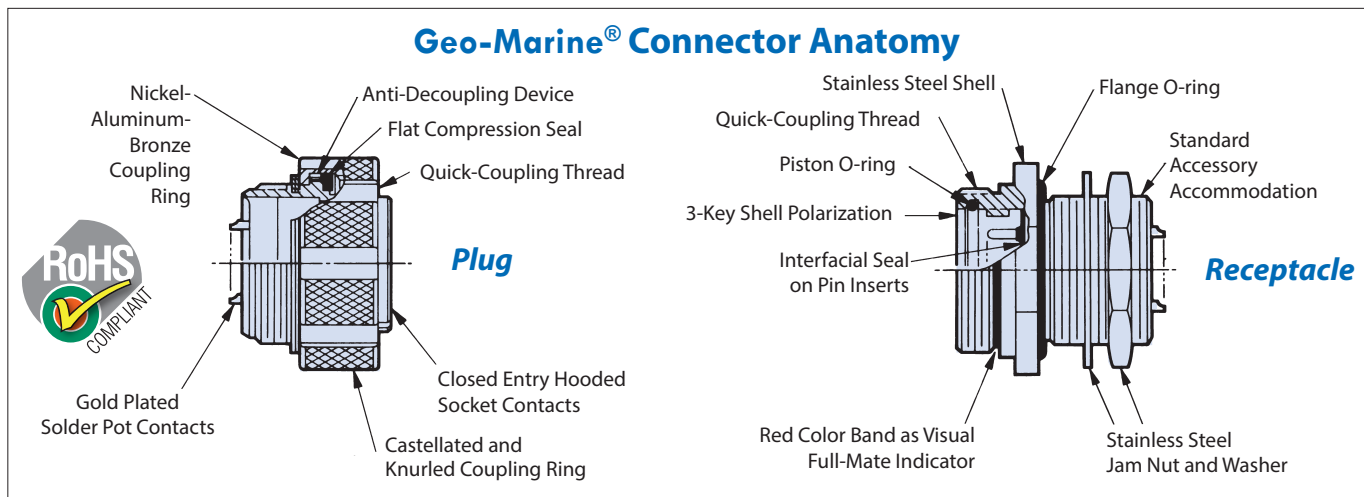



SERIES 22 Geo-Marine® Connectors



High-pressure environmental and fused-glass connectors



Connector Materials and Potting		
Item	Material	Potting
Connector Shells	CRS 316 SAE-AMS-QQ-S-763	Stycast 2651/Catalyst 9
Protective Covers	CRS 316 SAE-AMS-QQ-S-763	
Solder Mount Receptacle	CRS 316 SAE-AMS-QQ-S-763	
Plug Coupling Nut	Marine Bronze SAE AMS-4640	
Molding Adapters and Backshells	See individual product pages	
Insulators, Class "E"	Epiall 1908, Diallyl Phthalate or Hysol CP2-4289	
Insulators, Class "H"	Fused Vitreous Glass	
Contacts, Pin - Class "E"	Leaded Nickel Copper, CA 7021	
Contacts, Pin - Class "H"	Nickel-Iron Alloy 52 - MIL-I-23011, Class 2	
Contacts, Socket	Copper Alloy, CA7021	
Contacts, Socket Hood	CRS, SAE-AMS-QQ-S-763 AISI 305	
O-Rings	Nitrile (Buna-N) Rubber MIL-G-21569	
Interfacial and Peripheral Seals	Flourosilicone Rubber MIL-DTL-25988	

Glenair can design and fabricate overmolded **Geo-Marine**® cable assemblies featuring Viton® chemical resistant materials—terminated and tested to deliver advanced levels of sealing and durability.



APPLICATION NOTES

- All parts will be identified with manufacturer's name and part number, space permitting.
- Glenair 600 series backshell assembly tools are recommended for assembly and installation.
- Electrical ratings are based on connectors only, not terminated to a cable or conductors, with proper cleaning and drying after hydrostatic testing.
- On all length callouts, tolerance is $\pm .060$ unless otherwise specified.
- Metric dimensions appear in parentheses in diagrams and tables, based on 1 inch = 25.4 mm, for reference only. Unless otherwise specified, the following other dimensional tolerances apply:
 - .xx = $\pm .03$ (0.8)
 - .xxx = $\pm .015$ (0.4)
 - Lengths = $\pm .060$ (1.52)
 - Angles = $\pm 5^\circ$

Caution
Electrical safety limits must be established by the user. Peak voltages, switching surges, transients, etc., should be used to determine the safety of application.



SERIES MWDM Micro-D Connectors

- Typical operating temperature tolerance up to 200° C
- High density Micro TwistPin contacts set on .050 centers
- 9 to 130 insert arrangements
- Pigtail, PCB, solder cup, and flex terminations
- Single row, multi-row, low profile and high density insert arrangements
- QPL and commercial versions
- Same-day availability on all part numbers

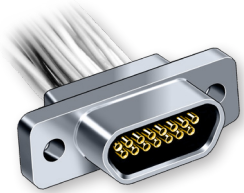

Standard



Hermetic

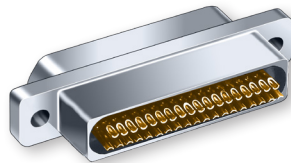

EMI Filter

High-vibration TwistPin contact Micro-D connectors offer outstanding mating performance, durability and minimal contact resistance

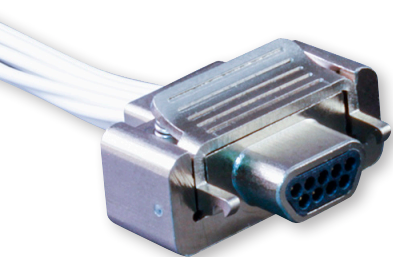

MasterLatch™

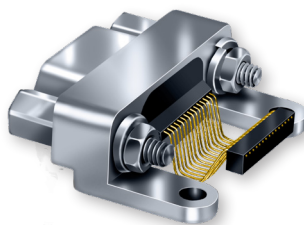

Surface Mount



Rear Panel Mount



Flex Circuit



MIL-DTL-83513 AND COMMERCIAL Micro-D Connectors



Mission-critical mating performance

Metal Shell Micro-D for Harnessing Applications

GRPM Solder Cup	GRPM Insulated Wire	GRPM Uninsulated Wire	MWDM Solder Cup	MWDM Insulated Wire	MWDM Back-To-Backs
Shielded Cable Assembly	MWDM Uninsulated Wire	GMDR Insulated Wire	GMDE Environmental	GSWM SpaceWire	GLM MasterLatch

Micro-Ds for Printed Circuit Board

GRPM-CBS	GRPM-CBR	MWDM-BS	MWDM-BR
MWDM-CBR	MWDM-CBS	90° Surface Mount	GMR7580
GMR7590	GMR7580C	GMR7590C	Right Angle Filter

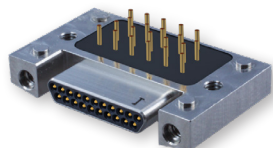

WellMaster™ 260



Sav-Con®

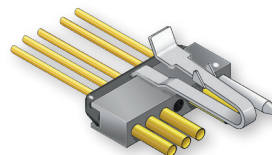

Latching MicroStrip

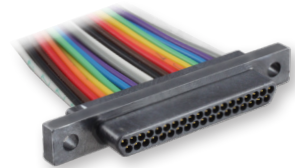

Low Profile



HIGH-TEMPERATURE

Well-Master[®] 260[°]

The Micro-D connector for serious, high-temperature applications

Standard Micro-D connectors are rated for +125°C. Glenair's MWDM Micro-D can withstand +150°C continuous operating temperature and can be upgraded to +200°C if assembled with special high temperature epoxies. But oil, gas and geothermal wells can subject electronic instruments to temperatures as high as +260°C. The GHTM Series Micro-D meets the need for a high density, high performance connector capable of handling this temperature. The GHTM features contacts made from a special alloy that resists softening when exposed to temperatures up to +260°C (500° F). Rugged passivated stainless steel shells and hardware, high temperature liquid crystal polymer (LCP) insulators allow these connectors to survive the most demanding environments. Unique angled mounting ears allow the Well-Master™ 260° to fit in confined spaces.

- +260°C operating temperature
- Angled mounting ears to fit in small diameter instruments
- High reliability twistpin contact system with special high temperature alloy
- .050" Pitch contact spacing for reduced size
- Solder cup, pre-wired or PCB

Well-Master^{260°}

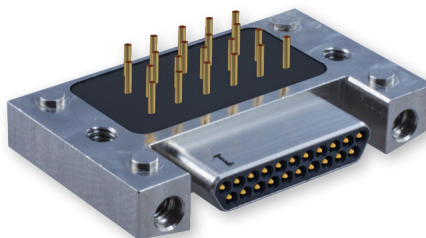

+260°C PCB Header

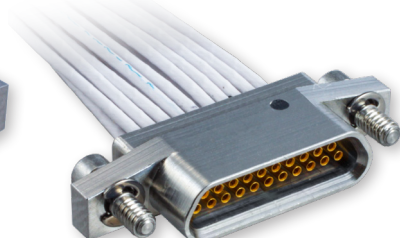

+260°C Cable Connector



SERIES GHTM WELL-MASTER 260° Downhole Micro-D Connector



Reference information / insert arrangements

In addition to extreme high temperature tolerance, and demating resistance to vibration and shock, the Glenair Well-Master™ 260° Micro-D connector features unique shell packaging designed to conform with the cylindrical shape of instrument housings. Special angled mounting ears facilitate incorporation of the connector into available space, and the Micro-D's overall reduced size compared to other rectangular connector solutions allows for more efficient utilization.

High Temperature Micro-D with insulated Wire Pigtails

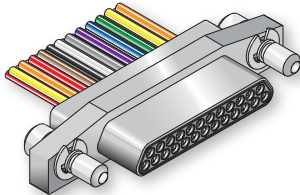

High Temperature PCB Header

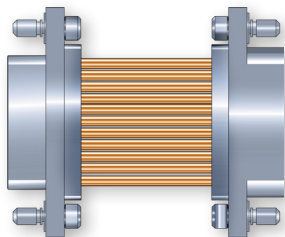
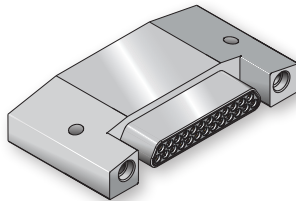

High Temperature Back-to-Back Micro-D



GHTM High Temperature Insert Arrangements (Pin Face View)

 1 2 3 4 5 6 7 8 9	 1 2 3 4 5 6 7 8 9 10 11 12 13 14 15	 1 2 3 4 5 6 7 8 9 10 11 12 13 14 15 16 17 18 19 20 21	 1 2 3 4 5 6 7 8 9 10 11 12 13 14 15 16 17 18 19 20 21 22 23 24 25
9	15	21	25
 1 2 3 4 5 6 7 8 9 10 11 12 13 14 15 16 17 18 19 20 21 22 23 24 25 26 27 28 29 30 31	 1 2 3 4 5 6 7 8 9 10 11 12 13 14 15 16 17 18 19 20 21 22 23 24 25 26 27 28 29 30 31 32 33 34 35 36 37	 1 2 3 4 5 6 7 8 9 10 11 12 13 14 15 16 17 18 19 20 21 22 23 24 25 26 27 28 29 30 31 32 33 34 35 36 37 38 39 40 41 42 43 44 45 46 47 48 49 50 51	
31	37	51	

Mating face of pin connector. Socket connector contact numbers are reversed.

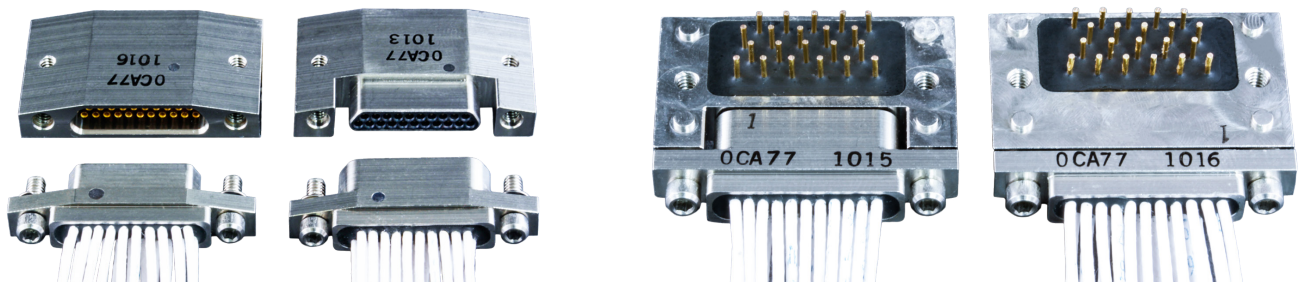



SERIES GHTM WELL-MASTER 260° Downhole Micro-D Connector



Insulated wire connector
with pin or socket contacts

GHTM PRE-WIRED CONNECTORS WITH +260°C MIL SPEC PTFE/POLYIMIDE WIRE

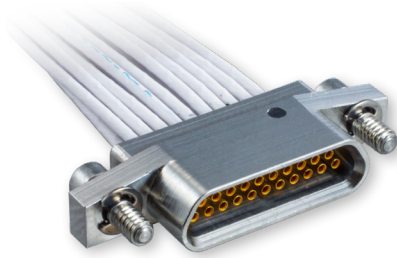

GHTM Well-Master™ 260° pre-wired Micro-D connectors withstand +260°C continuous operating temperature. These .050" pitch Micro-D connectors are terminated to #24 AWG insulated wire. Nickel-coated copper wire conforms to M22759/87, PTFE/polyimide insulation. Pin contacts are gold-plated high performance twistpin type and are recessed into insulator to prevent damage. Special nickel alloy contact material resists softening in high heat. Machined passivated stainless steel shell. Glass-filled high temperature LCP thermoplastic insulators. 100% hi-pot tested. Meets performance requirements of MIL-DTL-83513. Available with 9 to 51 contacts. 3 A., 600 Vac, -55°C to +260°C.

How To Order	
Sample Part Number	GHTM -31 S -4 T 1 -18 B
Series	GHTM Glenair High Temperature Micro
Shell Size	9, 15, 21, 25, 31, 37, 51
Contact Type	P - Pin/Plug S - Socket/Receptacle
Wire Gage (AWG)	4 - #24
Wire Type	T - PTFE/Polyimide Insulated Nickel Coated Copper
Wire Color	1 - White
Wire Length (Inches)	18 - Wire Length In Inches. "18" Specifies 18 Inches.
Mounting Hardware	B - Std. Thru-Hole (Ø.089/.095) M - Hex Head Jackscrew S - Slot Head Jackscrew P - Integral Jackpost See Mounting Hardware Table

GHTM Mounting Hardware		
B Std. Thru-Hole Mounting .096/.088 (2.43/2.23) Dia.	M and S #2-56 Jackscrews Slot head (S), Hex Head (M)	P Integral Jackpost #2-56
Pin	Pin	Pin
Socket	Socket	Socket



SERIES GHTM WELL-MASTER 260° Downhole Micro-D Connector



Back-to-back cable assemblies and right-angle PCB headers

GHTM BACK-TO-BACK CONNECTORS WITH +260°C MIL SPEC PTFE/POLYIMIDE WIRE

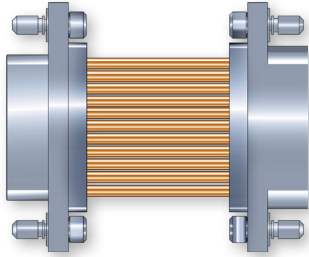

GHTM Well-Master® 260° back-to-back Micro-D cable assemblies withstand +260°C continuous operating temperature. These .050" pitch Micro-D connectors are terminated to #24 AWG insulated wire. Nickel-coated copper wire conforms to M22759/87, PTFE/polyimide insulation. Pin contacts are gold-plated high performance twistpin type and are recessed into insulator to prevent damage. Special nickel alloy contact material resists softening in high heat. Machined passivated stainless steel shell. Glass-filled high temperature LCP thermoplastic insulators. Meets performance requirements of MIL-DTL-83513. Available with 9 to 51 contacts. 3 A., 600 Vac, -55°C to +260°C.

How To Order	
Sample Part Number	GHTM -31 GS -6 T 1 -18 B
Series	GHTM Glenair High Temperature Micro-D
Shell Size	9, 15, 21, 25, 31, 37, 51
Contact Type	GP - Pin Connector Both Ends GS - Socket Connector Both Ends CS - Pin Connector to Socket Connector
Wire Gage (AWG)	4 - #24
Wire Type	T - PTFE/Polyimide Insulated Nickel Coated Copper
Wire Color	1 - White
Wire Length (Inches)	18 - Wire length in Inche (2" minimum for 2 rows, 3" minimum for 3 rows)
Mounting Hardware	B - Std. Thru-Hole M - Hex Head Jackscrew S - Slot Head Jackscrew P - Integral Jackpost (See Mounting Hardware Table, opposite page)

GHTM RIGHT ANGLE PRINTED CIRCUIT BOARD HEADERS



GHTM Well-Master® 260° right angle PCB Micro-D connectors withstand +260°C continuous operating temperature. These .050" pitch Micro-D connectors have .020 inch diameter (0.51mm) gold-plated PC terminals. Terminal spacing is .100 inch by .075 inch (2.54 by 1.91mm). Pin contacts are gold-plated high performance twistpin type and are recessed into insulator to prevent damage. Special nickel alloy contact material resists softening in high heat. Machined passivated stainless steel shell with integral jackpost. Glass-filled high temperature LCP thermoplastic insulators to withstand soldering heat. Meets performance requirements of MIL-DTL-83513. Available with 9 to 51 contacts. 3 A., 600 Vac, -55°C to +260°C.

How To Order	
Sample Part Number	GHTM -25 P RA P -110
Series	GHTM Glenair High Temperature Micro-D
Shell Size	9, 15, 21, 25, 31, 37, 51
Gender	P = Pin/Plug S = Socket/Receptacle
Termination Type	RA = Right Angle Board Mount
Mounting Hardware	P - Integral Jackpost; See Mounting Hardware Table opposite page
Terminal Length	All lengths ±.015 (.38) .080, .110, .125, .140, .150, .175, .190, .205



SERIES ITS-Ex

Industrial-strength power and signal connector series qualified for use in hazardous zone interconnect applications

Designed for safe operation in petrochemical refineries, oil & gas drilling platforms, and other explosion zone applications, the Glenair ITS-Ex series connector is optimized for life-of-system durability and reliability. Qualified by the globally-recognized IEC and IECEx standards bodies, the connector series is suitable for use in application areas where flammable gases and vapors are present as a normal condition of operation (group IIC) and with temperature classes T6 and T5, zones 1 and 2; and for applications where potentially flammable dust is present as a normal condition of operation (group IIIC) and with temperature classes T80°C and T95°C in zone 21 and 22.

Series ITS-Ex is designed for easy and repeatable termination of armored and unarmored cables built to IEEE 45, IEC, BS, DIN, and JIC standards. A full range of power and signal contacts, from size #16 to size #0 in over 40 insert arrangements are available to address all common voltage, wire size and connector service class ratings.

Special Ex design attributes of the series include an integral labyrinth flame path cooling zone, 2-part epoxy potting well, fixed in-line receptacles for attachment of cables to cable management brackets and trays, set screw (grub screw) secured protective safety covers, and durable life-of-system Ex marking labels.



- Utilizes all standard features of 5015 inserts, contacts, tools, etc.
- Grub nuts (set screw) to lock coupling nut
- Long plug barrels provide cooling zone
- Labyrinth gas exit port/pathway augments cooling
- Accessory accommodation for potted glands
- Increased wall thickness
- Stainless steel and Marine Bronze available



SERIES ITS-EX IECEx/ATEX Qualified Explosive Zone Connectors



RANGE OF APPLICATIONS

- Automotive refuelling or petrol stations
- Oil & gas extraction
- Oil refineries
- Gas pipelines and distribution
- Chemical processing plants
- Aircraft refuelling and hangars
- Transportation
- Pharmaceuticals
- Food processing
- Metal surface grinding
- Sugar refineries
- Grain handling and storage
- Coal mining

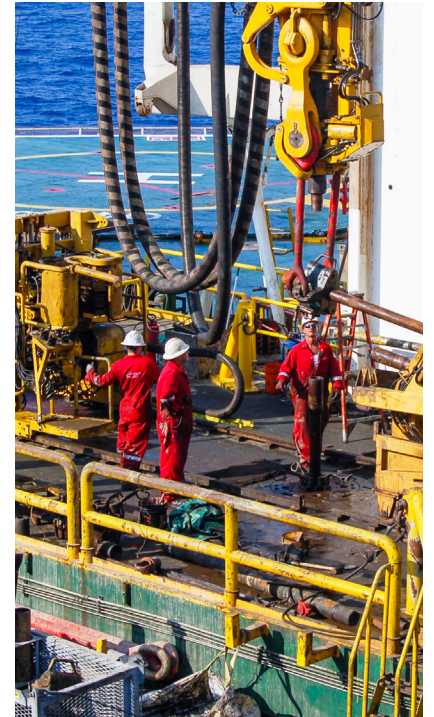
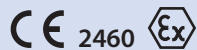

Photo: Mikulova



ATEX Marking



II 2 G Ex db IIC T6, T5 Gb
 II 2 D Ex tb IIIC T80°C, T95°C Db IP68
 -40°C ≤ Tamb ≤ +40°C (T6, T80°C) or +55°C (T5, T95°C)

IECEx Marking

Ex db IIC T6, T5 Gb
 Ex tb IIIC T80°C, T95°C Db IP68
 -40°C ≤ Tamb ≤ +40°C (T6, T80°C) or +55°C (T5, T95°C)

Glenair ITS-Ex series encompasses both in-line cable plugs and receptacles as well as fixed bulkhead-mountable designs



MARINE BRONZE Seacrow Connectors

For geophysical/offshore and other harsh-environment applications

Glenair manufactures connectors qualified to VG96929, VG95234 and VG95328 standards. These connectors are mostly used in harsh-environment military applications for ground vehicles and ground systems. Our new Marine Bronze version increases the level of robustness of these connectors to be successfully used in all severe environment navy installations, as well as off-shore platforms, sea ports, geological and oceanographic applications.

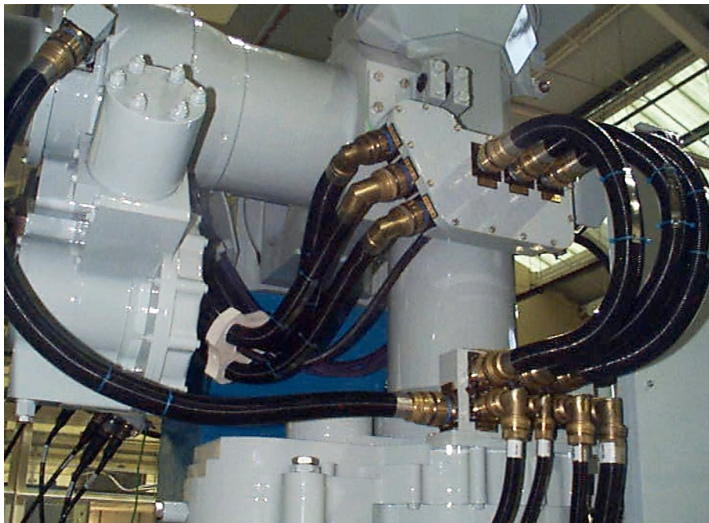

- **Marine bronze alloy for superior corrosion resistance in seawater and other harsh environments**
- **Ideal for shipboard and offshore drilling applications**
- **Available in Series ITS (5015 reverse-bayonet), Series IPT (26482), Series IGE (Single-pole high-power VG96929) and Series IT (5015 threaded)**
- **IP67 environmental sealing in mated condition; IP68 available**
- **Hundreds of available contact arrangements for both power and signal as well as hybrid applications**



SEACROW MARINE BRONZE
Topside / Shipboard
Environmental Connectors
Series overview



ITS-MB MIL-C-5015 TYPE REVERSE-BAYONET CONNECTORS



VG95234 Equivalent Marine Bronze Series

ITS-MB connectors are compliant with VG95234, using all the same insert arrangements available in the standard ITS Reverse Bayonet Connectors catalog. Typically they are used for power and signal transmission, with wires from 26 AWG to 4/0. A wide variety of backshells allow the ITS-MB to accept jacketed cables, single or multi-poles, with or without RFI/EMI shielding, conduits with PG or metric thread. IP67 protection is the standard performance. IP68 on request.

IT-MB MIL-C-5015G TYPE THREADED CONNECTORS



MIL-C-5015 Compliant Marine Bronze Series

IT-MB is a threaded connector compliant with the MIL-DTL-5015 standard. All the electrical characteristics are available in the IT standard catalog. IT-MB family is a threaded version mostly used for power and signal, with IP67 standard performance sealing.

IPT-MB MIL-DTL-26482 TYPE HIGH DENSITY BAYONET CONNECTORS



VG95328 Equivalent Marine Bronze Series

IPT-MB connectors are the choice for reliability when 20-16 AWG signal cables are used. The insert arrangements as well as the electrical characteristics are detailed in the IPT IPT-SE catalog. Backshells suitable for EMI shield terminations and heat shrink boots are also available.

The receptacle is also available with PCB contacts. IP67 protection is the standard performance. IP68 on request.

IGE-MB MIL-C-5015 TYPE REVERSE-BAYONET SINGLE-POLE POWER CONNECTORS

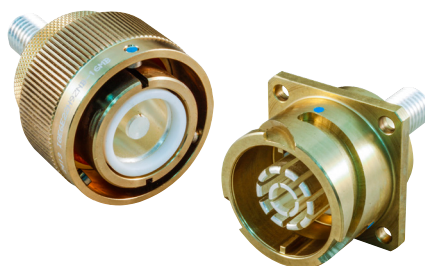

VG96929 Equivalent Marine Bronze Series

IGE-MB High Power Single Pole Connectors are used with cables from 16 to 240 mmq.

These connectors achieve high-performance working current and peak current, and are ideal for engines, power supplies, and power distribution boxes. Several backshells are available, either straight or 90° elbows for the most reliable cable accommodation. See the VG96929 catalog for detailed electrical characteristics. IP67 protection is the standard performance. IP68 on request.



TURNKEY

Overmolded and PBOF Assemblies

Terminated, tested, and ready for use

Glenair overmolded cable assemblies may be supplied with materials such as Viton®, Duralectric™, polyurethane, EPDM, Santoprene™, or polyamide to optimize harsh-environment performance for the Oil & Gas industry. Assemblies may be specially shielded with conductive overbraiding for superior mechanical protection, flexibility, and resistance to RFI and other forms of electromagnetic interference. Fast turnaround and quality fabrication in overmolded cable assemblies depends on capital investment in tooling, injection molding equipment, planetary wire stranders, and braiding machines.



Rugged point-to-point overmolded assembly with Geo-Marine® connectors



SeaKing PBOF assembly

ADVANTAGES OF OVERMOLDING

- Waterproof sealing
- Robust mechanical protection
- Permanent protection of terminations
- Resistance to chemicals and fuels
- No induced cold flow stress
- Electrical isolation and insulation
- Reduced wear damage
- Flexible routing and cable entry
- Repeatable assembly performance



TURNKEY

Interconnect Cable Assemblies



with environmentally-resistant Duralectric™ jacketing

DURALECTRIC™ APPLICATION AND MATERIAL PROPERTIES

Duralectric™ is high-performance elastomeric material for use as wire insulation, cable jacketing, conduit jacketing, cable/conduit overmolding, and molded boots. Perfectly suited for immersion, chemical or caustic fluid exposure, temperature extremes, UV radiation and more.

- Service temperature range: -65°C to 225°C
- Duralectric K (Kelvin) range: -110° to 225°C
- Fire-resistant, Low Smoke-Zero Halogen (LSZH)
- Mil-aero and industrial fluid-resistant
- Accelerated UV/sunlight resistant, 53 year equivalent exposure
- Ozone resistant IAW ASTM D1149
- Moldable and extrudable

DURALECTRIC™ APPLICATION SHOWCASE



Bulk jacketed Duralectric™ cable with TurboFlex® flexible power cabling for harsh-environment power applications with cable routing challenges



Complex multibranch overmolded cable assembly with rugged Duralectric™ jacketing



Shipboard application with Duralectric™ jacketing and overmolding



Turboflex® power pylon cable assembly with Duralectric™ jacketing

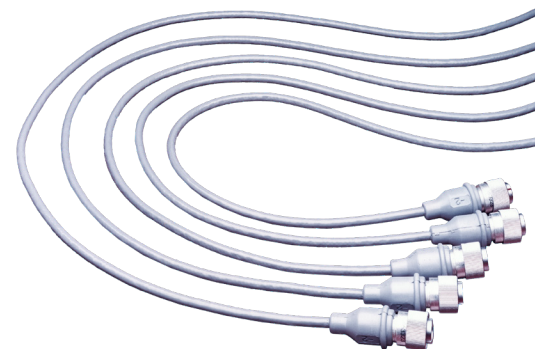

Duralectric™ jacketing employed in environmental commercial application



Turnkey connectorized flex/PCB cable assemblies incorporating Glenair's broad range of innovative small form-factor circular and rectangular PCB connector solutions. All terminations backpotted for compliance with conformal coating processes.

GLENAIR SIGNATURE PCB CONNECTOR TYPES AVAILABLE IN TURNKEY FLEX ASSEMBLIES

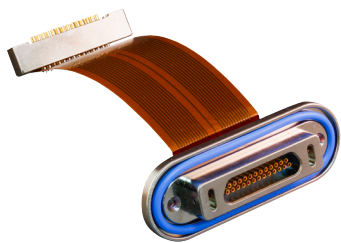

Series MWD Micro-D and innovative pogo-pin AlphaLink

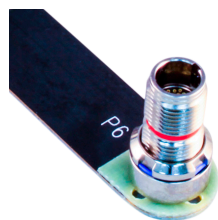

Series 88 SuperFly

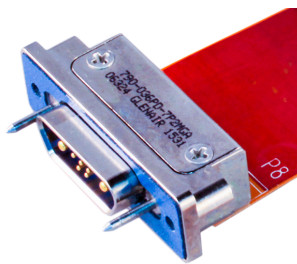

Series 79 Micro-Crimp

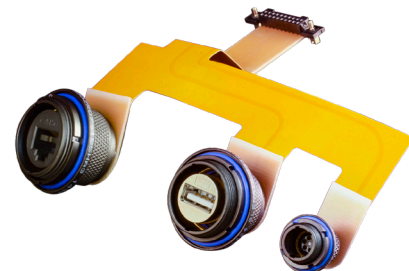

SuperSeal RJ45 and USB

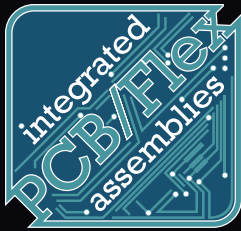

TURNKEY PCB/Flex Circuit Assemblies with Glenair signature PC tail connectors



MULIBRANCH FLEX / PCB ASSEMBLIES WITH GLENAIR SIGNATURE CONNECTORS

Space-grade Micro-D flex assembly with NASA EEE-INST-002 screening

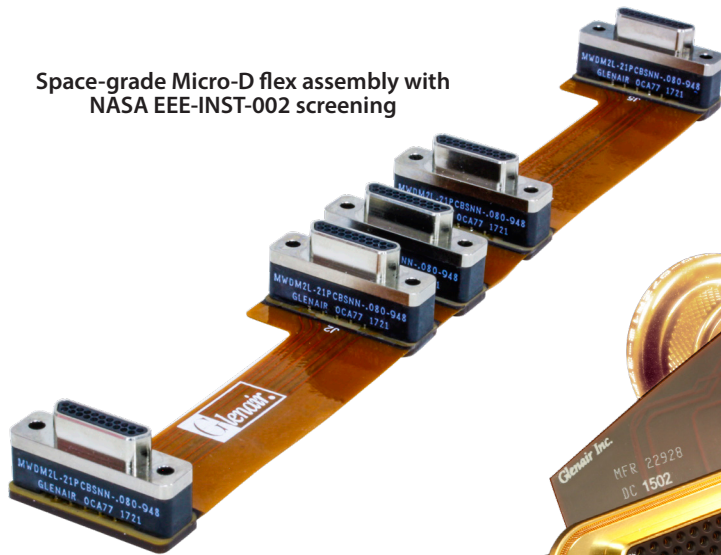

High-shock matched-impedance Mighty Mouse assembly with flex circuit



Space-grade Series 28 HiPer-D to Series 80 Mighty Mouse I/O jumper



Dual-gang series 20 Super-Twin™ I/O connector to AlphaLink SL PCB connector

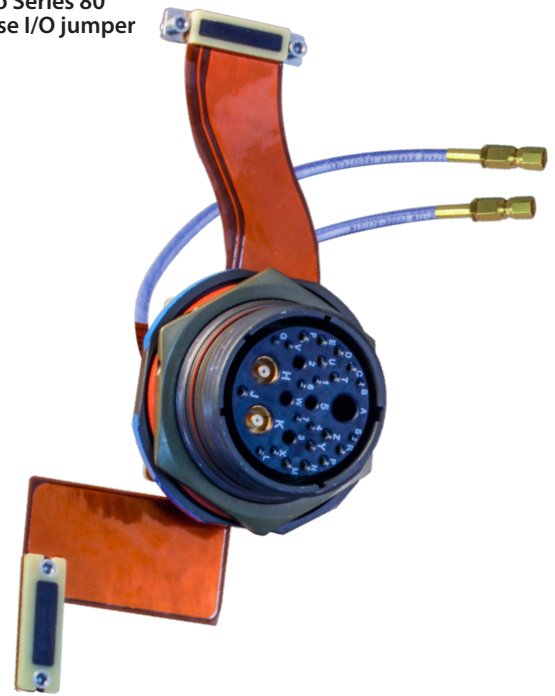

Hybrid flex/rigid flex multibranch Micro-D and Series 23 SuperNine flex assembly with discrete RF circuits

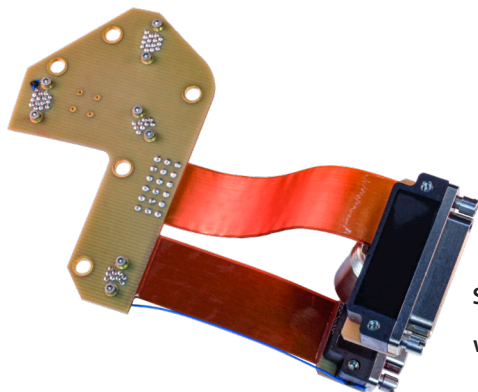

Stacked Micro-D I/O connectors with flex jumper to rigid PCB assembly

Hydrostatic Test Lab

GLENDALE, CALIFORNIA

Special behind-the-scenes tour of Glenair's hydrostatic test lab for high-pressure electrical and fiber optic interconnects

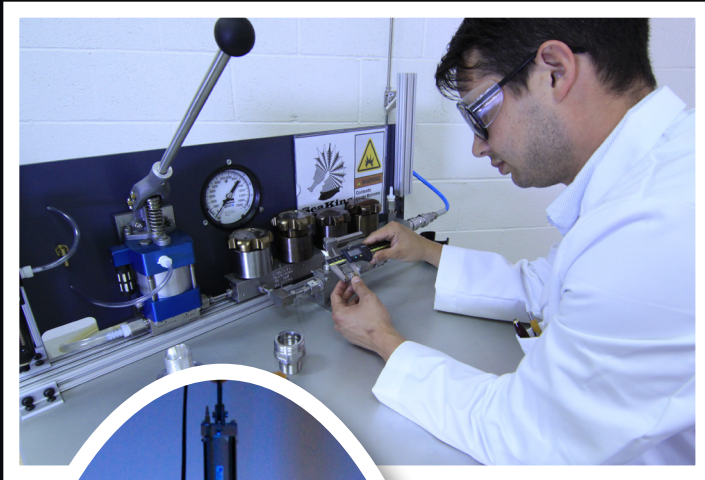

DISCRETE CONNECTOR TESTING: All Glenair high-pressure interconnects are subjected to 100% inspection and test

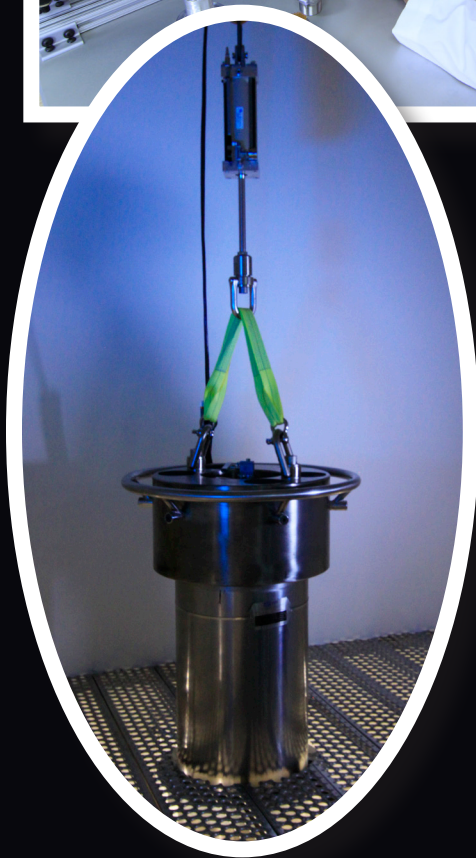

LARGE PRESSURE VESSELS: Built to accommodate complete cable assemblies, mated connectors, and customer-supplied subassemblies

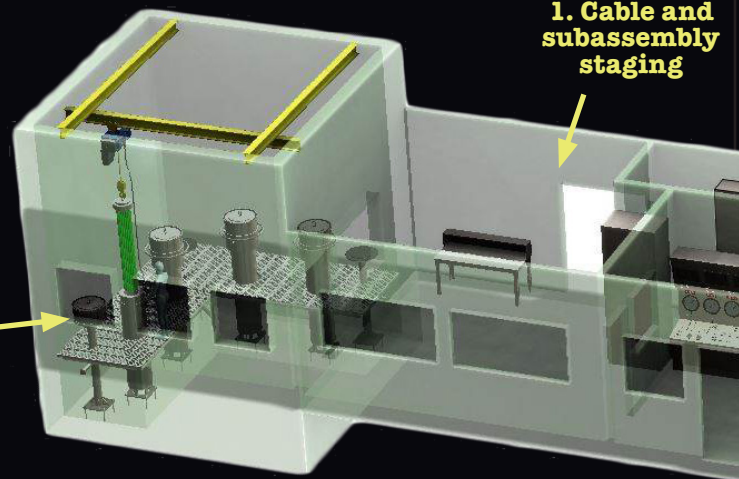

2. Large cable and subassembly pressure test bunker

1. Cable and subassembly staging



TECHNICAL STAFF: Knowledgeable and trained subsea specialists perform both in-house product qualification testing, as well as customer subassemblies

CONTROL ROOM: The modular consoles in the control room provide for up to 8 pressure circuits, operating in Manual mode or Automated. Each circuit is capable of a maximum of 16.5K psi. **Monitors display:** Automated Test Profiles, Data Acquisition, remote viewing of Test rooms and more. System is network connected for access to Profiles and distribution of test reports.



3. Hydrostatic test lab control room

4. Production connector staging

5. Small connector pressure test bunker

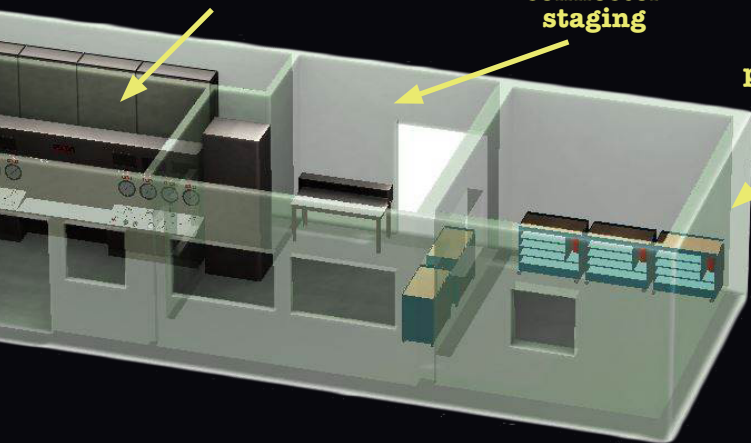

SeaKing™ and SuperG55™ QUALIFICATION TESTING: Both Glenair Series 70 SeaKing and SuperG55 rugged dry-mate subsea connectors have been tested and qualified to their 10K psi pressure rating—open-face and mated—in Glenair’s state-of-the-art hydrostatic test lab. Additional testing included mating cycles, salt spray, and electrical continuity.



Glenair Hydrostatic Test Lab Technical Specifications and Pressure Test Standards	
Pressure test profiles	Automated or manual
Maximum test pressure	16.5K psi
Data acquisition types	Pressure, time, temperature, and electrical performance
Performance monitoring under pressure	I/R, continuity, insertion loss, and backreflection (optical)
Industry profiles	All major oil & gas standards
Custom profiles	Yes, including customer-supplied subassemblies
Capacity (large pressure vessels)	Working volume = 12" diameter x 72" depth; Test specimen weight up to 1500 lbs.



MISSION-CRITICAL INTERCONNECT SOLUTIONS

Glenair, Inc.

1211 Air Way • Glendale, California • 91201-2497

Telephone: 818-247-6000 • Fax: 818-500-9912 • sales@glenair.com

www.glenair.com

Glenair Power Products Group

20 Sterling Drive
Wallingford, CT
06492

Telephone:
203-741-1115
Facsimile:
203-741-0053
sales@glenair.com

Glenair UK Ltd

40 Lower Oakham Way
Oakham Business Park
Mansfield, Notts
NG18 5BY England

Telephone:
+44-1623-638100
Facsimile:
+44-1623-638111
sales@glenair.co.uk

Glenair Microway Systems

7000 North Lawndale Avenue
Lincolnwood, IL
60712

Telephone:
847-679-8833
Facsimile:
847-679-8849

Glenair Nordic AB

Gustav III : S Boulevard 42
SE-169 27 Solna
Sweden

Telephone:
+46-8-50550000
sales@glenair.se

Glenair GmbH

Schaberweg 28
61348 Bad Homburg
Germany

Telephone:
06172 / 68 16 0
Facsimile:
06172 / 68 16 90
info@glenair.de

Glenair Iberica

C/ La Vega, 16
45612 Velada
Spain

Telephone:
+34-925-89-29-88
Facsimile:
+34-925-89-29-87
sales@glenair.es

Glenair Italia S.p.A.

Via Del Lavoro, 7
40057 Quarto Inferiore –
Granarolo dell'Emilia
Bologna, Italy

Telephone:
+39-051-782811
Facsimile:
+39-051-782259
info@glenair.it

Glenair France SARL

7, Avenue Parmentier
Immeuble Central Parc #2
31200 Toulouse
France

Telephone:
+33-5-34-40-97-40
Facsimile:
+33-5-61-47-86-10
sales@glenair.fr

Glenair Korea

B-1304 Gunpo IT Valley
148 Gosan-Ro, Gunpo-Si
Kyunggi-Do, Korea
435-733

Telephone:
+82-31-8068-1090
Facsimile:
+82-31-8068-1092
sales@glenair.kr