

# Searching the **RIGHT** POWER SOLUTION Only **P-DUKE**



IEC 60950-1 | IEC 62368-1

IEC 60601-1 Edition 3.1 | IEC 60601-1-2 4th Edition

# Who We Are

Founded in 1992, P-DUKE 100% concentrated on the research, development, production, sales and service of DC/DC Converters and related products. With products sold under our own brand name, P-DUKE to Europe, America, and Japan, we accumulate great skills through years of experience and open up better product awareness which leads to further cooperation with world-famous companies, making P-DUKE an important role in the global market.

## 3S Commitment: A Full Range of Services

Through multiple methods, P-DUKE keeps following up the ever-changing pulse of power industry, and performs our 3S commitments to the highest. We provide a full range of product line, from standard types to customized products. Even the application engineering service of the final product systems is also our forte. What we have and what we do is exactly what you need, and this is why P-DUKE makes an irreplaceable role among customers and partners.

## Global Logistic, Local Management

We expand our own brand, P-DUKE through various marketing channels to construct a worldwide network. Apart from stabilizing the existing markets, P-DUKE operates strategy management on Niche markets by changing from distribution to local direct selling. With the faith we hold, "Global Logistic, Local Management", we'll keep pushing new innovations toward power modules and therefore creating a full range of product line.



P-DUKE has been respecting and emphasizing the importance of Intellectual Property Rights. We have obtained multinational patents so far. To all the advanced companies in this industry, do not violate our Intellectual Property. Once any enterprises or individuals are found guilty of the infringement of intellectual property rights may be subject to investigate. P-DUKE has the right to protect our customers and be responsible for shareholders' equity.

P-DUKE's patents include the following: US 7,894,214 B1, US 8,817,495 B2, Nr. 20 2010 006 407.4, ZL 2011 2 C088132.5 ...

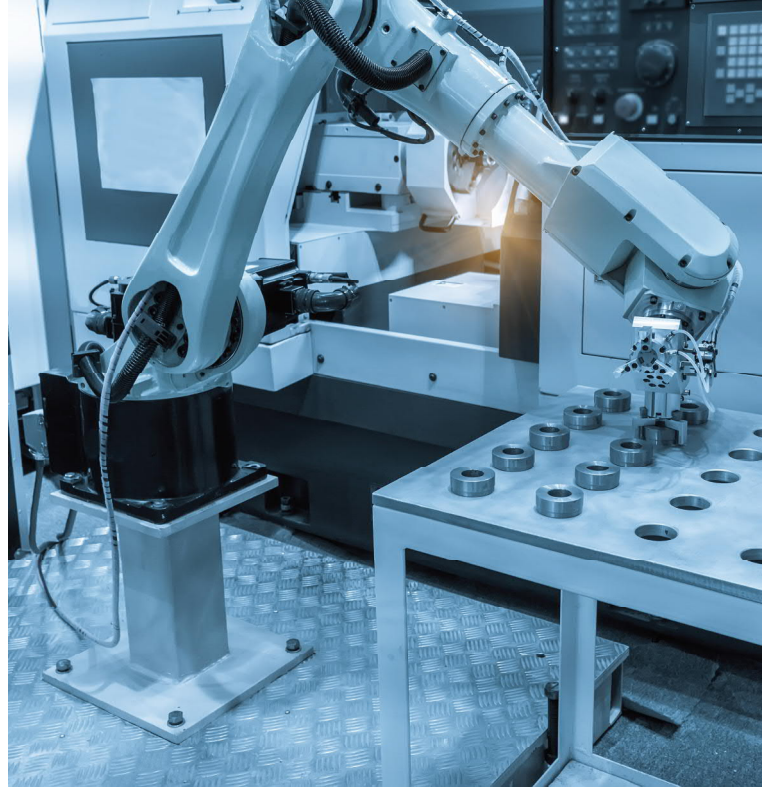

## Power the World, the Innovator of Power Solutions

P-DUKE devotes a lot of efforts in nurturing research staffs. We introduce latest technology skills along with the research instrument and CAD to our factory, making our researches to reach the world-class level.

We've acquired ISO 9001 Quality Management System certification, and safety approval of UL and CE. Our products own many design and manufacturing process patents, and our medical product even won the Innovation Award of TAITRONICS in 2014 and 2015.

P-DUKE has an excellent R & D team. In addition to develop products of high power density and green concept, we also put efforts on researches and developments for multiple kinds of products in order to enhance the completeness of the product specification.



- High Efficiency
- High Isolation
- Low Leakage
- Protection
- Reliable

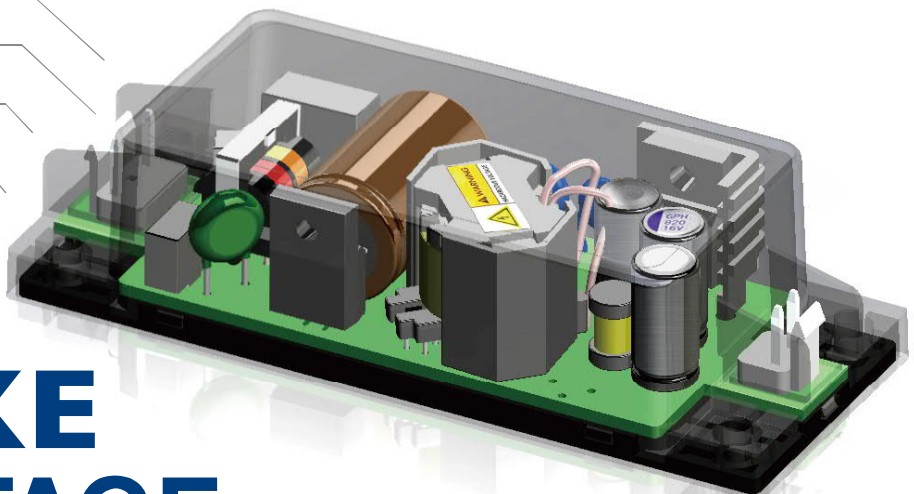

# P-DUKE ADVANTAGE



## Over 25-Year Manufacturing Experience

Provide Customized Products

Excellent Service

In the medical applications, the instruments would touch human's body directly or indirectly. Therefore it requires much stricter for safety and stability on statutory specification than other products.

We provide various medical application solutions based on high-quality and innovative design. Also it's our commitment to develop precise and stable products to bring customers the safety, efficiency and quality consistency.

We have more than 25 years' experience in developing and manufacturing power supplies. For medical applications, we provide high isolation and low leakage current products and have been approved by FCC, EN60601-1, international specifications certification

Besides standard products, we can offer customized solution through excellent design ability to provide total power solution to customers.



## IEC 60601-1 OVERVIEW

### WHAT IS IEC 60601-1?

IEC 60601 is a series of technical standards for the safety and effectiveness of medical electrical equipment.

### PRIMARY STANDARD

The primary standard of medical device design is officially called IEC 60601-1 medical electrical equipment - Part 1: General requirements for basic safety and essential performance. It is referred to as IEC 60601-1 or just “60601” simply and compliance with this standard has become a basic requirement to bring new medical devices to market in many countries.

### REFORMATION OF IEC 60601

The IEC60601-1 2 edition only illustrated basic safety issues to protect from any electrical, mechanical, radiation, and thermal hazards. However, it did not require devices to remain being functional and enough safe nor take the essential performance of the device into account under pass/fail result test. Therefore, the IEC60601-1 3 edition introduces specifications for essential performance that requires medical/healthcare equipment to continue functioning throughout the test process.

Because the medical and healthcare safety certification of AC/DC power supply and DC/DC converter take very important role of the medical safety regulation, the IEC60601-1 3 edition have introduced some new concept like the basic performance of equipment...etc., and it has distinguished the protection level toward devise operator (MOOP) and patient (MOPP), which includes requirements for safety distance, insulation schemes and dielectric strength.

The classification defines various indicators, such as isolation, insulation, creep-age, clearance, and leakage current that are safe and allowed to be touched by devise operator or patient.

# Medical Insulation System Structure

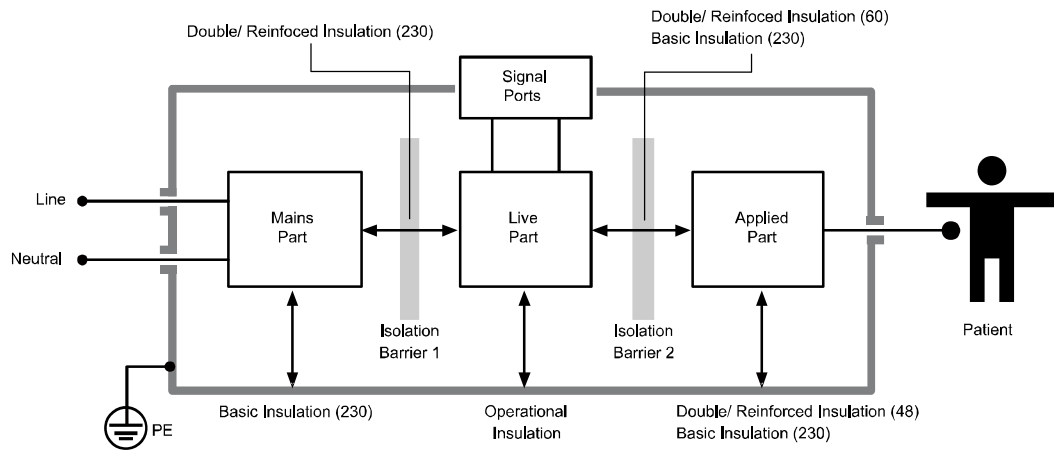

## Insulation Requirements

Insulation		1 MOP Basic	2 MOP Double/ Reinforced
MOOP	Air Clearance	2.0 mm	4.0 mm
	Creepage	3,2 mm	6,4 mm
	Isolation Voltage	1500 VAC	3000 VAC
MOPP	Air Clearance	2,5 mm	5,0 mm
	Creepage	4.0 mm	8.0 mm
	Isolation Voltage	1500 VAC	4000 VAC

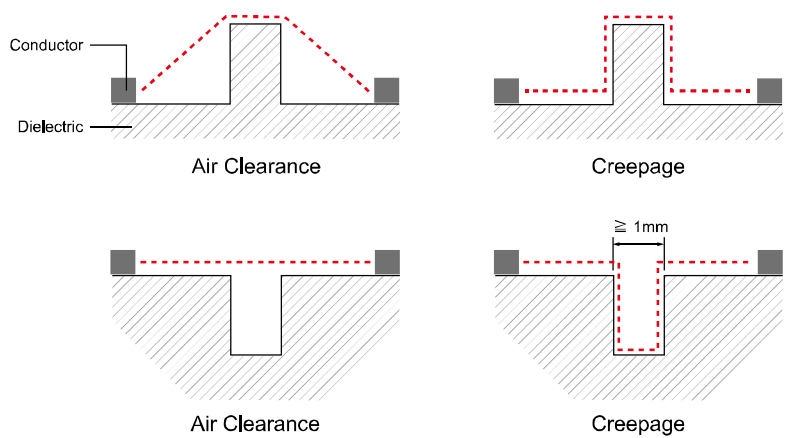

## Leakage Current

Leakage Current		Type B		Type BF		Type CF	
		NC	SFC	NC	SFC	NC	SFC
Earth Leakage Current		5 mA	10 mA	5 mA	10 mA	5 mA	10 mA
Touch Current		100 $\mu$ A	500 $\mu$ A	100 $\mu$ A	500 $\mu$ A	100 $\mu$ A	500 $\mu$ A
Patient Leakage Current	AC	100 $\mu$ A	500 $\mu$ A	100 $\mu$ A	500 $\mu$ A	10 $\mu$ A	50 $\mu$ A
	DC	10 $\mu$ A	50 $\mu$ A	10 $\mu$ A	50 $\mu$ A	10 $\mu$ A	50 $\mu$ A
Patient Auxiliary Current	AC	100 $\mu$ A	500 $\mu$ A	100 $\mu$ A	500 $\mu$ A	10 $\mu$ A	50 $\mu$ A
	DC	10 $\mu$ A	50 $\mu$ A	10 $\mu$ A	50 $\mu$ A	10 $\mu$ A	50 $\mu$ A

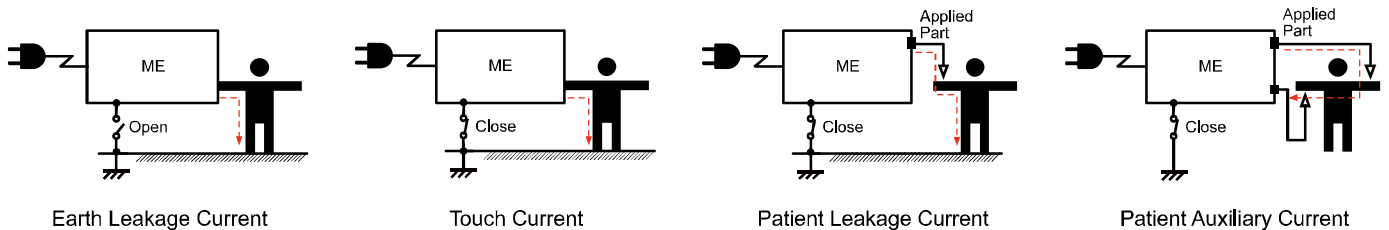



# Medical Power Solutions

## AC/DC Power Supplies and DC/DC Converters for Medical Application

P-DUKE provides 2-30W DC/DC and 15-450 AC/DC with many different kind of package to meet different space and installation requirements in medical applications.

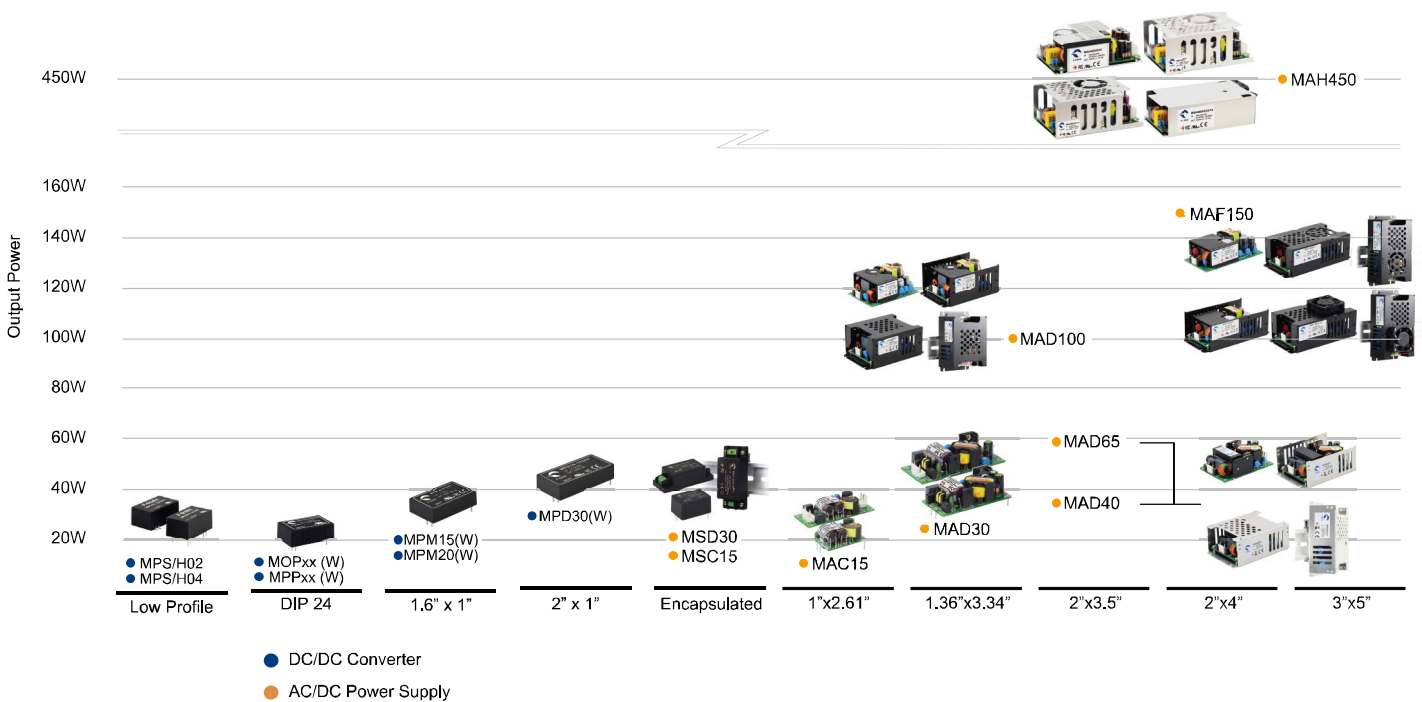



## Medical Product Line

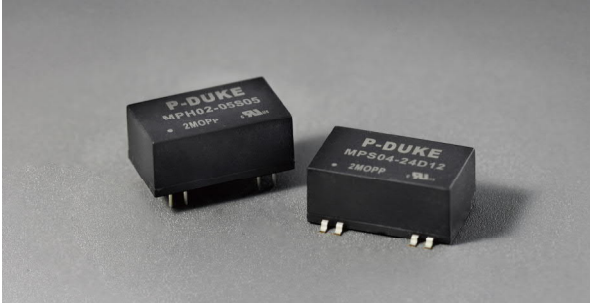

### MPS / MPH series **NEW**

2-3.5 Watts | DC-DC

- 2:1 Input Voltage : 4.5-12, 9-18, 18-36, 36-75 VDC
- Output Voltage : 3.3, 5, 9, 12, 15, 24,  $\pm 12$ ,  $\pm 15$  VDC
- Up To 5000VAC Isolation Voltage
- 2MOPP
- Low Profile
- Standard SMD Package
- Through Hole Type

\*3.3 Vout only for MPS/H02

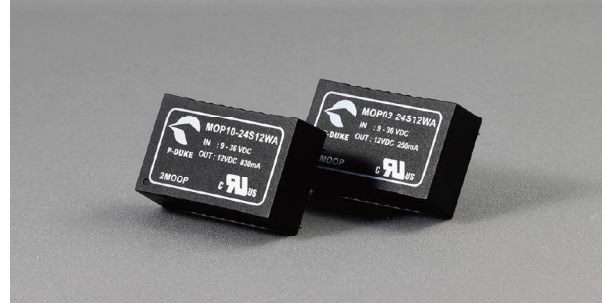

### MOPxx / MOPxxW series

3-10 Watts | DC-DC

- 2:1 & 4:1 Input Voltage : 4.5-9, 9-18, 18-36, 36-75VDC  
9-36, 18-75VDC
- Output Voltage : 3.3, 5, 12, 15, 24,  $\pm 5$ ,  $\pm 12$ ,  $\pm 15$  VDC
- Up To 3000VAC Isolation Voltage
- Built-in EN55032 EMI Class A Filter
- 2MOPP
- Standard DIP 24 Package
- Through Hole Type



### MPPxx / MPPxxW series

3-10 Watts | DC-DC

- 2:1 & 4:1 Input Voltage : 4.5-9, 9-18, 18-36, 36-75VDC  
9-36, 18-75VDC
- Output Voltage : 3.3, 5, 12, 15, 24,  $\pm 5$ ,  $\pm 12$ ,  $\pm 15$  VDC
- Up To 5000VAC Isolation Voltage
- Built-in EN55032 EMI Class A Filter
- 2MOPP
- Standard DIP 24 Package
- Through Hole Type

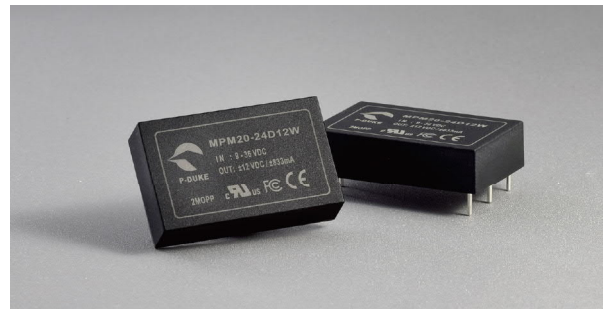

### MPM15 / MPM15W MPM20 / MPM20W series **NEW**

15-20 Watts | DC-DC

- 2:1 & 4:1 Input Voltage : 9-18, 18-36, 36-75VDC  
9-36, 18-75VDC
- Output Voltage : 5, 12, 15, 24,  $\pm 5$ ,  $\pm 12$ ,  $\pm 15$  VDC
- Up To 5000VAC Isolation Voltage
- Built-in EN55032 EMI Class A Filter
- 2MOPP
- Standard 1.6" x 1" Package
- Through Hole Type

## Medical Product Line



### MPD30 / MPD30W series **NEW**

30 Watts | DC-DC

- 2:1 & 4:1 Input Voltage : 9-18, 18-36, 36-75VDC  
9-36, 18-75VDC
- Output Voltage : 5, 12, 15, 24,  $\pm 5$ ,  $\pm 12$ ,  $\pm 15$  VDC
- Up To 5000VAC Isolation Voltage
- Built-in EN55032 EMI Class A Filter
- 2MOPP
- Standard 2" x 1" Package
- Through Hole Type



### MAC15 / MSC15 series

15 Watts | AC-DC

- Input Voltage : 85-264VAC, 120-370VDC
- Output Voltage : 3.3, 5, 7.5, 9, 12, 15, 18, 24, 28, 36, 48, 53 VDC
- Up To 4000VAC Isolation Voltage
- Built-in EN55032 EMI Class B Filter
- Wide Operating Ambient Temp  $-40^{\circ}\text{C}$  to  $85^{\circ}\text{C}$
- 1.00" x 2.61" x 0.62" Package
- Through Hole, Screw Terminal and Connector Type

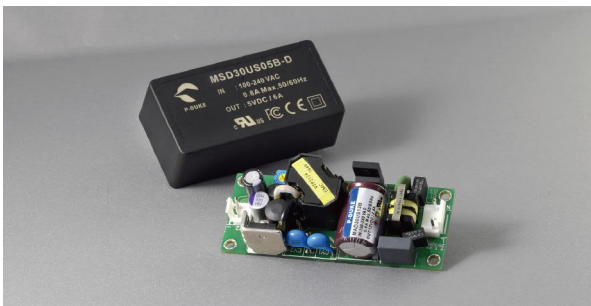

### MAD30 / MSD30 series

30 Watts | AC-DC

- Input Voltage : 85-264VAC, 120-370VDC
- Output Voltage : 3.3, 5, 7.5, 9, 12, 15, 18, 24, 28, 36, 48, 53 VDC
- Up To 4000VAC Isolation Voltage
- Built-in EN55032 EMI Class B Filter
- Wide Operating Ambient Temp  $-40^{\circ}\text{C}$  to  $85^{\circ}\text{C}$
- 1.36" x 3.34" x 0.77" Package
- Through Hole, Screw Terminal and Connector Type



### MSD40 / MSD65 series **NEW**

40-65 Watts | AC-DC

- Input Voltage : 85-264VAC, 120-370VDC
- Output Voltage : 5, 7.5, 9, 12, 15, 18, 24, 28, 36, 48, 53 VDC
- Up To 4000VAC Isolation Voltage
- Built-in EN55032 EMI Class B Filter
- Wide Operating Ambient Temp  $-40^{\circ}\text{C}$  to  $85^{\circ}\text{C}$
- 2.22" x 3.22" x 1.20" Package
- Through Hole, Screw Terminal and Connector Type

## Medical Product Line



### MAD40 / MAD65 series

40-65 Watts | AC-DC

- Input Voltage : 85-264VAC, 120-370VDC
- Output Voltage : 5, 7.5, 9, 12, 15, 18, 24, 28, 36, 48, 53 VDC
- Up To 4000VAC Isolation Voltage
- Built-in EN55032 EMI Class B Filter
- Single Output & Multi-Output
- Low Leakage Current Under 75 $\mu$ A
- Wide Operating Ambient Temp  $-40^{\circ}\text{C}$  to  $85^{\circ}\text{C}$
- 2.00" x 3.00" x 0.94" Package
- Open Frame, U Chassis, Enclosed, Din-rail  
Screw Terminal and Connector Type

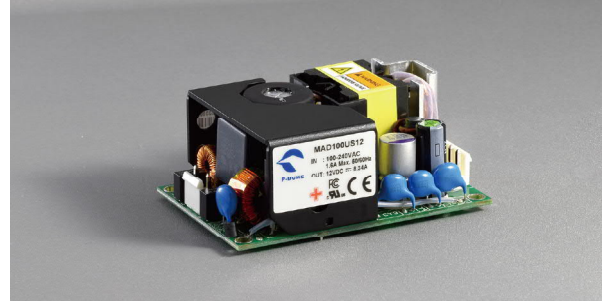

### MAD100 series

100 Watts | AC-DC

- Input Voltage : 85-264VAC, 120-370VDC
- Output Voltage : 12, 15, 18, 24, 28, 36, 48 VDC
- Up To 4000VAC Isolation Voltage
- Built-in EN55032 EMI Class B Filter
- Low Leakage Current Under 75 $\mu$ A
- 2.00" x 3.00" x 1.16" Package
- Open Frame, U Chassis, Enclosed, Din-rail  
Screw Terminal and Connector Type



### MAF150 series

150 Watts | AC-DC

- Input Voltage : 85-264VAC, 120-370VDC
- Output Voltage : 12, 15, 18, 24, 28, 36, 48 VDC
- Up To 4000VAC Isolation Voltage
- 2.00" x 4.00" x 1.16" Package
- Open Frame, U Chassis, Enclosed, Din-rail  
Screw Terminal and Connector Type



### MAH450 series

450 Watts | AC-DC

- Input Voltage : 85-264VAC, 120-370VDC
- Output Voltage : 12, 15, 24, 28, 36, 48, 53 VDC
- Up To 4000VAC Isolation Voltage
- Built-in EMI Class B Filter
- Wide Operating Ambient Temp  $-40^{\circ}\text{C}$  to  $85^{\circ}\text{C}$
- 3.00" x 5.00" x 1.58" Package
- Open Frame and Enclosed Type



**P-DUKE**  
**POWER**

#### World Headquarters



P-DUKE Technology Co., Ltd.  
NO.36, 22nd Rd., Taichung Industrial Park, Taichung,  
40850, Taiwan, R.O.C  
TEL:+886-4-2359-0668  
FAX:+886-4-2359-1337  
E-MAIL:sale@pduke.com  
WEB:www.pduke.com

#### U.S.A Branch



P-DUKE Technology, Inc.  
717 Brea Canyon Road, Suite#1 Walnut, CA 91789  
TEL:+1-909-5985000  
FAX:+1-909-5985705  
E-MAIL:sale-usa@pduke.com  
WEB:us.pduke.com

Please Contact Local Distributor or visit our website