



OUTDOOR
CONNECTORS

OUTDOOR WIRELESS SOLUTIONS

Full Line Catalog



SIMPLIFICATION *is our INNOVATION*

Radiall is a community of dedicated individuals with a shared purpose: simplify life for all those who innovate.

Our manufacturing expertise allows us to deliver lighter and smaller products that simplify implementation and drive performance. We recognize that simplification starts with us, but proves its true benefits when it reaches you.



TABLE OF CONTENTS

NEX10™ Series R180	1
4.3-10 Series R183	2
4.1-9.5 Series R170	3
N Series R161	4
7/16 Series R185	5
Jumper Series R296	6
Adapter Series R191/R192	7
RXF Series R2F/R4F	8
OCTIS Series	9
HEP ² R Plating	10
Part Number Index	11



NEX10™ SERIES

R180

Contents

NEX10™

Introduction 1-4

Characteristics 1-5

Plugs and jack 1-6 to 1-7

Accessories and tools 1-7

Between series adapters 1-8 to 1-9

Panel drilling 1-10

SECTION 1 TABLE OF CONTENTS

Introduction

Radiall's NEX10™ series is a miniature and lightweight RF coaxial connector with excellent intermodulation performance for outdoor telecom applications up to 20 GHz. To develop this solution, Radiall partnered with two leading RF connector manufacturers to develop NEX10™ - a new compact extremely robust Low PIM connector.

NEX10™ is the perfect solution for customers' requiring new generation equipment in the Telecom market that combines top performance with exceptional benefits and features.

To meet the performance needs of customers NEX10™ offers exceptional performance up to 20 GHz and also features a compact design which is 50% smaller than 4.3-10. This unique solution also offers separation of electrical and mechanical reference planes, which maximizes intermodulation performance under static and dynamic vibrations and torque stress conditions.

NEX10™ is available in multiple configurations:

- Jack: square flange, bulkhead
- Plug: straight & right angle
- Screw-on & push-pull coupling mechanism
- Multi coax
- Additional boot
- Jumper

FEATURES & BENEFITS

- Robust design for outdoor usage
- Low PIM, independent of applied torque
- Multiple coupling mechanism of push-pull and torque
- RF shielding
- Optimized for 1/4" superflexible corrugated and smaller flexible cables
- 12.7mm minimum flange height
- Contact areas protected from damage

APPLICATIONS

- Small Cell and MIMO
- DAS/In-building
- Antennas, radios and filter output
- Outdoor and indoor
- Applications requiring PIM stability in a compact size
- Multi-coax/Blind mate applications



Characteristics

	Values / Remarks
--	------------------

ELECTRICAL CHARACTERISTICS

Impedance	50Ω			
Frequency	DC - 20 GHz			
PIM (passive intermodulation)	-166 dBc, 2x43 & 2x40 dBm (static and dynamic)			
Power	100W @ 2GHz @ 85°C 50W @ 2GHz @ 105°C 250W @ 2GHz @ 25°C			
Return loss (typical)	DC-4 GHz	4-6 GHz	6-10 GHz	10-20 GHz
	≥ 36 dB	≥ 34 dB	≥ 30 dB	≥ 20 dB
Screening effectiveness	- 110 dB typical - 90 dB typical - 70 dB typical			
Lightning protection	±1 kA 10/350 μs pulse and ±4 kA 8/20 μs pulse ±1 kA 10/350 μs pulse and ±4 kA 8/20 μs pulse			
Lightning protection	±1 kA 10/350 μs pulse and ±4 kA 8/20 μs pulse ±1 kA 10/350 μs pulse and ±4 kA 8/20 μs pulse			
Contact resistance	Center contact 2.0 mΩ Outer contact 1.0 mΩ			
Voltage	Operating voltage: 1kV Breakdown voltage: 3kV			

MECHANICAL CHARACTERISTICS

Coupling mechanisms	Torque, Push-Pull			
Durability (mating cycles)	100 min. 500 for test and measurement types			
Boot protection	Designated area for sealing			
Mating characteristics	50 N typical 35 N typical			
• Quick-lock	50 N typical 35 N typical			
- Engagement force	50 N typical 35 N typical			
- Disengagement force	50 N typical 35 N typical			
• Screw	1.5Nm (Maximum 5Nm)			
- Recommended torque	1.5Nm (Maximum 5Nm)			
Interface retention force	Quick-lock: 150 N min. Screw: 500 N min.			
Cable size diameter	Optimized for cables upto 1/4"			
Bending force	5Nm			

ENVIRONMENTAL CHARACTERISTICS

Temperature range	-55°C/+125°C			
Corrosion	48 hours salt mist test			
Interface ingress protection	IP68 (24hrs, 1m, room temp, mated pair)			
RoHS	Compliant			

Plugs and Jacks

STRAIGHT PLUG SOLDER TYPE

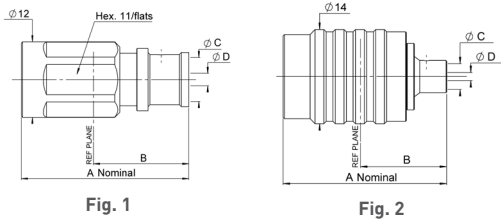

Cable group	Cable group dia.	Part number	Fig.	Dimensions				Finish	Coupling mechanism
				A	B	C	D		
RG402	.141	R180 052 007	1	24.3	12.8	3.8	1.2	Silver + BBR	Screw-on
		R180 052 017	2						Push-pull
HCF 1/4" Cu2YAICu	1/4" superflexible corrugated	R180 060 007	2	26.7	15.2	7	2		Push-pull
		R180 060 017	1						Screw-on

BULKHEAD JACKS

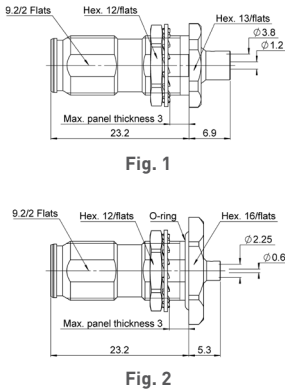

Cable group	Cable group dia.	Part number	Fig.	Finish	Panel drilling	Note
RG402	.141	R180 300 007	1	Silver + BBR	P03	Solder
KS1 / RG405	.085	R180 301 007	2			

Jacks

FLANGE JACKS

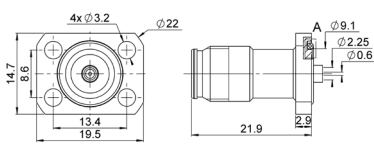

Fig. 1

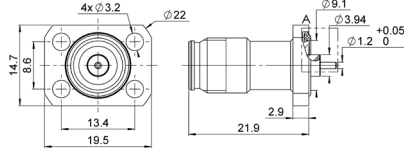

Fig. 2

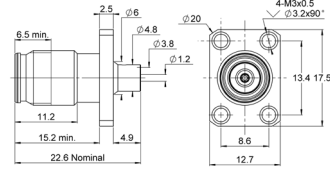



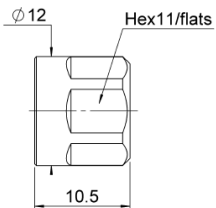

Fig. 3

Cable group	Cable group dia.	Part number	Fig.	Finish	Panel drilling	Note	
-	-	R180 540 007		1	P01	Pin dia 1.2	
KS1 / RG405	.085	R180 415 007		2		P02	Solder
RG402	.141	R180 252 007		3			

Accessories and Tools

PROTECTIVE CAPS







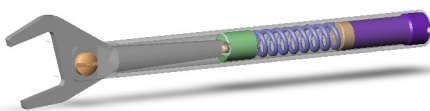

Part number	Coupling mechanism	Note	Material
R180 805 010	Screw-on	IP67	ABS
R180 805 007			Metal

TOOLS

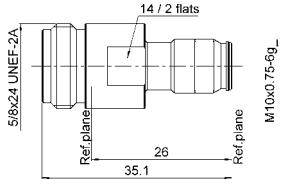

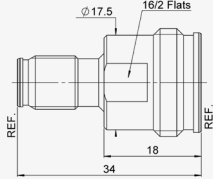

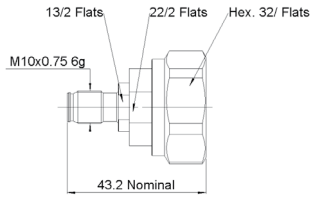

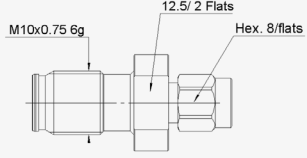

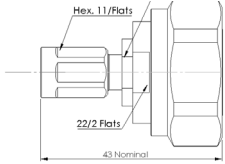

Part number	Description	Across flats D (mm)
R282 303 050	Torque wrench 1.5N.m	11

Between Series Adapters

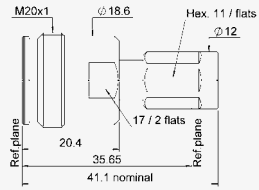
Part number	Interface 1	Interface 2	2D Shape	
R191 620 027		N Jack female		
R191 620 037		NEX10™ Jack female		
R191 620 017			7/16 Plug male	
R191 621 017			SMA 3.5 Plug male	

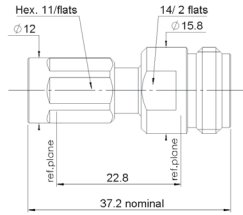
Between Series Adapters

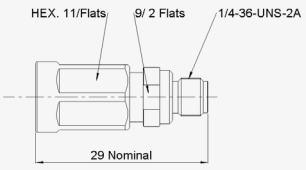
NEX10™

Part number		Interface 1	Interface 2	2D Shape
R191 631 007		NEX10™ Screw Plug male	7/16 Plug male	
R191 620 047			4.3-10 Jack female	
R191 630 007			N Jack female	
R191 621 007			SMA 3.5 Jack female	
R191 620 007			NEX10™ Push-pull Plug male	N Jack female

Panel Drilling

P01

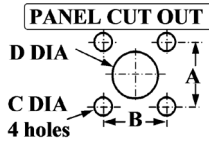

	mm		inch	
	Maxi	mini	Maxi	mini
A	8.65	8.55	0.340	0.336
B	13.45	13.35	0.529	0.525
C	3.3	3.2	0.129	0.078
D	4.2	4.1	0.165	0.161

P02

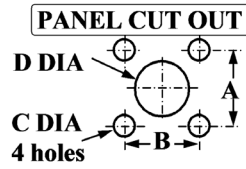

	mm		inch	
	Maxi	mini	Maxi	mini
A	8.65	8.55	0.34	0.336
B	13.45	13.35	0.529	0.525
C	3.3	3.2	0.129	0.125
D	7.3	7.2	0.287	0.283

P03

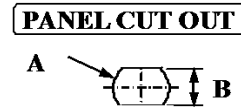

	mm		inch	
	Maxi	mini	Maxi	mini
A	10.1	10	0.397	0.393
B	9.3	9.2	0.366	0.362



4.3-10 SERIES

R183

Contents

4.3-10

Introduction	2-4
Characteristics	2-5
Plugs	2-6 to 2-7
Jacks	2-7
Accessories and tools	2-8
Panel drilling	2-8
Low power terminations	2-8
Medium power terminations	2-9
Medium power attenuators	2-9

SECTION 2 TABLE OF CONTENTS

Introduction

50Ω

DC - 6 GHz

GENERAL

- Low Intermodulation connector
- Screw-on & push-pull coupling mechanism
- High power rating
- 30% smaller & 60% lighter than 7/16

APPLICABLE STANDARDS

- IEC 61169
- MIL PRF 39012

APPLICATIONS

- Telecom
- Medical
- Industrial
- Indoor and outdoor use

Overview

Designed for major telecom equipment manufacturers, the 4.3-10 series offers a small, lightweight solution for outdoor telecom applications where high performance is essential and low intermodulation is required.

Radiall's broad product portfolio includes the 4.3-10, 4.1-9.5, 7/16 and the innovative QLI (Quick Lock Low Intermodulation) connector. These solutions are suitable for harsh environments where reliability is required.

Available in a variety of configurations including:

- Jack/Bulkhead
- Square flange receptacles and plugs
- Right angle models
- Solder, crimp and clamp models
- Screw-on and push-pull coupling mechanism

4.3-10 connectors are a lightweight solution and are 30% smaller and 60% lighter than comparable 7/16 square flange jack receptacles. The new interface features a high intermodulation level ranging from 0-6 GHz and provides a low intermodulation level at <-166dBc.

Radiall's 4.3-10 connector solution is designed in accordance with international standards and manufactured to meet environmental safety requirements.

HIGH PERFORMANCE

- Impedance 50Ω
- Frequency range DC ~ 6 GHz
- Very low intermodulation level $\leq -166\text{dBc}$
- Screw-on and push-pull coupling mechanism for safety and ease of use
- VSWR 1.04 + 0.01 v f
- Meets all requirements for IP67
- High mating life
- 3 step connection: Engage, Push & Lock
- Intuitive design concept
- Lightweight
- Reduced size allows more space for other components
- RF Power: Up to 500 W @ 2 GHz

Characteristics

Test / Characteristics	Values / Remarks
------------------------	------------------

ELECTRICAL CHARACTERISTICS

Impedance	50Ω
Frequency range	DC - 6 GHz
Typical VSWR	1.04 + 0.01 f (GHz)
Maximum insertion loss	0.05 √f (GHz) dB
Insulation resistance	5000 MΩ min
Voltage rating	<=1000 Veff
Dielectric withstanding voltage	≥2500 Veff
Contact resistance	≤ 1 mΩ ≤ 1.5 mΩ
• Center contact	
• Outer contact	
Power	500W @ 2 GHz
Intermodulation	≤165dBc (>120 dBm) 2x20W
Typical RF leakage	-110dB@3 GHz; -100dB@3-6 GHz

MECHANICAL CHARACTERISTICS

Mechanical endurance	100 cycles	
Mating force (push-pull version)	≤100 N ≤80 N	IEC 61169-1 §9.3.6
• Engagement force for mating		
• Separation force for mating		
Mating torque (tool screw type)	5 N. m	IEC 61169-1 §9.3.6
• Torque		
Mating mechanical retention force	450 N min.	
Cable retention force	350 N mini with 1/2" S cable	
Vibration	10g 2 Hz to 200 Hz	IEC 61169-1 § 9.3.3

ENVIRONMENTAL CHARACTERISTICS

Temperature range	- 55 °C ~ + 90 °C	
Moisture resistance	IP67	
Corrosion salt spray	48h	Up to 720 with HEP2R*

MATERIALS

Connector bodies	Brass
Male center contact	Bronze / Brass
Female center contact	Bronze
Outer contact	Brass
Other metallic parts	Brass
Insulators	PTFE

PLATING

Bodies	BBR
Outer contact	BBR
Center contact	Silver

* Contact us

Plugs

STRAIGHT PLUG FOR FLEXIBLE AND SEMI-RIGID CABLE

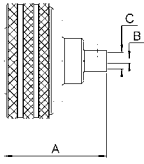

Cable group	Cable group dia.	Part number		Dimensions			Captive center contact	Finish	Coupling mechanism	Note
				A	B	C				
RG402 / KS2 / BELDEN 1673A / HC90000(3) / SUCOFORM 141	.141	R183 052 007		21.9	0.96	3.7	Yes	Silver + BBR	Push-pull	Solder

STRAIGHT PLUGS FOR CORRUGATED CABLES

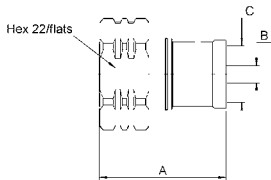

Fig. 1

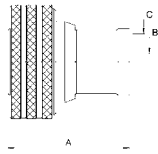





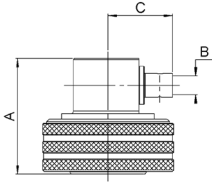

Fig. 2

Cable group dia.	Part number		Fig.	Dimensions			Captive center contact	Finish	Coupling mechanism	Note
				A	B	C				
1/2" super-flexible corrugated	R183 031 007		1	27.9	3.80	12.55	Yes	Silver + BBR	Screw-on	Solder
	R183 031 017		2						Push-pull	
1/4" super-flexible corrugated	R183 030 017		1	23.8	2	6.8			Screw-on	
	R183 030 007		2						Push-pull	
3/8" super-flexible corrugated	R183 032 007		1	25.9	2.8	9.45			Screw-on	

Plugs

RIGHT ANGLE PLUG FOR HANDFORMABLE AND SEMI-RIGID CABLES



Cable group	Cable group dia.	Part number	Dimensions			Captive center contact	Finish	Coupling mechanism	Note
			A	B	C				
RG402 / KS2	.141	R183 197 007	21.7	3.65	12.5	Yes	Silver + BBR	Push-pull	Solder



RIGHT ANGLE PLUG FOR CORRUGATED CABLES

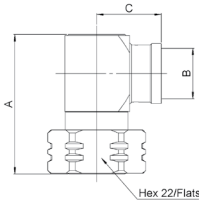

Cable group dia.	Part number	Dimensions			Captive center contact	Finish	Coupling mechanism	Note
		A	B	C				
1/2" superflexible corrugated	R183 165 007	34.7	12.55	16.15	Yes	Silver + BBR	Screw-on	Solder



Jacks

STRAIGHT SQUARE FLANGE JACKS

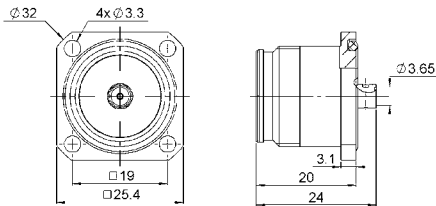

Cable group	Cable group dia.	Part number	Captive center contact	Panel drilling	Finish
RG402	.141	R183 252 007	Yes	P01	Silver / BBR



SQUARE FLANGE JACK RECEPTACLES

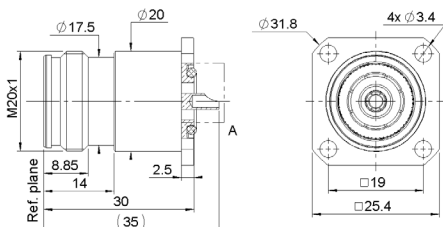



Part number	Captive center contact	Panel drilling	Finish	Note
R183 405 067	Yes	P02	Silver / BBR	Solder pot

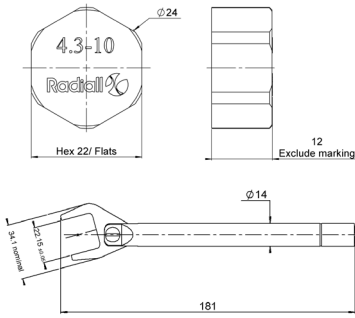

Accessories and Tools



Part number		Note
R183 804 020		IP67 for mated condition UV resistance
R282 303 240		Torque wrench 5N.m

Panel Drilling

P01

PANEL CUT OUT

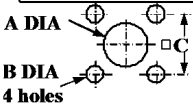

A DIA
B DIA
4 holes

	mm		inch	
	Maxi	mini	Maxi	mini
A	10.1	10	0.397	0.393
B	3.4	3.3	0.133	0.129
C	19.05	18.95	0.75	0.746

P02

PANEL CUT OUT

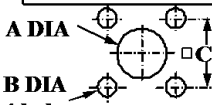

A DIA
B DIA
4 holes

	mm		inch	
	Maxi	mini	Maxi	mini
A	7.46	7.3	0.293	0.287
B	3.6	3.5	0.141	0.137
C	19.05	18.95	0.75	0.746

Low Power Terminations

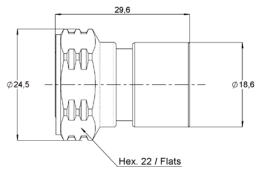

Fig. 1

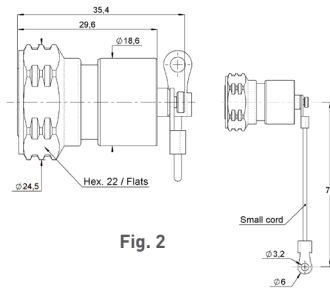

Fig. 2

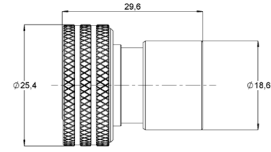

Fig. 3

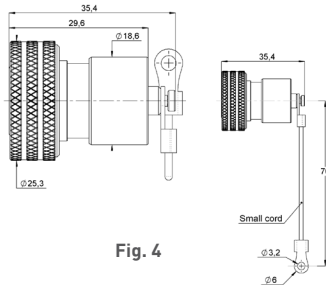

Fig. 4

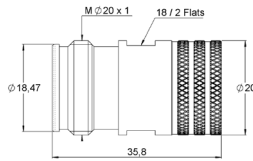

Fig. 5

Frequency DC to (GHz)	VSWR max.	Return loss min. (dB)	Power rating (W)		Impedance (Ω)	Gender	Part number	Fig.
			average	peak				
6	1.25	19.1	2	500	50±5%	Male screw	R404 1D1 000	1
							R404 1D1 121 ⁽¹⁾	2
						Male push-pull	R404 1D2 000	3
							R404 1D2 121 ⁽¹⁾	4
						Female	R404 1D5 000	5

[1] with cord

Medium Power Terminations

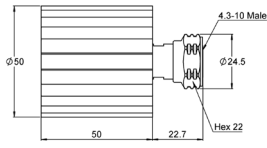

Fig. 1

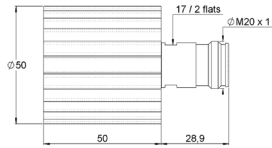

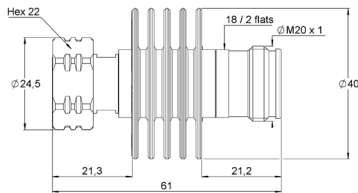



Fig. 2

Frequency DC to (GHz)	VSWR max.	Return loss min. (dB)	Power rating (W)		Impedance (Ω)	Gender	Part number		Fig.
			average	peak					
6	1.3	17.7	30	2,000	50±5%	Male screw	R404 758 000		1
						Female	R404 759 000		2

Medium Power Attenuators



Frequency DC to (GHz)	VSWR max.	Return loss min. (dB)	Power rating (W)		Nom. Attenuation (dB)	Max dev.	Part number	
			average	peak				
6	1.15	14.0	15	250	xx	±0.6	R415 6xx 000	

Available attenuation value: xx = 03, 06, 10, 20 dB



4.1-9.5 SERIES

R170

Contents



4.1-9.5

Introduction 3-4

Characteristics 3-5

Plugs and jack 3-6

SECTION 3 TABLE OF CONTENTS



Introduction

50Ω

DC - 6 GHz

GENERAL

- Screw-on coupling mechanism
- High power rating
- 20% smaller & 50% lighter than 7/16
- Low coupling torque
- Low intermodulation

APPLICABLE STANDARDS

- IEC 61169
- MIL PRF 39012

APPLICATIONS

- Telecom
- Medical
- Industrial
- Indoor and outdoor use

Overview

Radiall completes its power connector range with 4.1-9.5, a low intermodulation series. 4.1-9.5 is designed to provide similar performance to 7/16 with smaller size and weight, using a proven screw-on coupling mechanism. With its corrosion resistance, Radiall 4.1-9.5 is the ideal choice for telecom applications where severe conditions require a high performance and robust connector.

HIGH PERFORMANCE

- Impedance 50Ω
- Frequency range DC ~ 6 GHz
- Very low intermodulation level $\leq -125\text{dBc}$
- Screw-on coupling mechanism
- Coupling retention force 450 N
- VSWR 1.02 + 0.02 \sqrt{f}
- Meets all requirements for IP67
- High mating life
- Light weight
- Reduced size allows more space for other components
- RF Power: Up to 1000 W @ 1 GHz

Characteristics

Test / Characteristics	Values / Remarks
------------------------	------------------

ELECTRICAL CHARACTERISTICS

Impedance	50Ω
Frequency range	0 - 6 GHz
Typical VSWR	1.02 + 0.02 F
Maximum insertion loss	0.05 vF (GHz)
Insulation resistance	5000 MΩ min
Voltage rating	<=1400 Veff
Dielectric withstanding voltage	<2500 Veff
Contact resistance	≤ 1.5 mΩ
Power	1KW @ 1 GHz
Intermodulation	-160 dBc

MECHANICAL CHARACTERISTICS

Mechanical endurance	100 cycles
Disengagement force	<12 N
Mating torque	1000 N.cm

ENVIRONMENTAL CHARACTERISTICS

Temperature range	- 55 °C ~ + 155 °C
Sealing	IP67

MATERIALS

Connector bodies	Brass
Male center contact	Brass
Female center contact	Beryllium Copper / Bronze
Other metallic parts	Brass
Insulators	PTFE

PLATING

Bodies	BBR2
Outer contact	BBR2
Center contact	Silver

Plugs and jack

STRAIGHT PLUGS

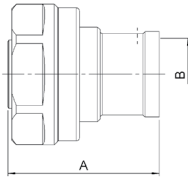

Fig. 1

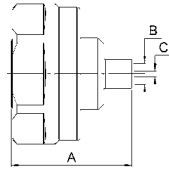

Fig. 2

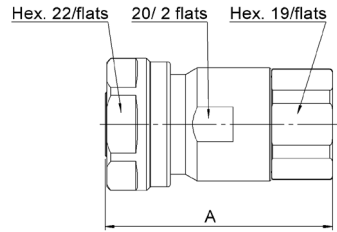
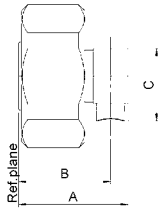

Fig. 3

Cable group dia.	Part number	Fig.	Dimensions			Captive center contact	Finish	Packaging	Note	
			A	B	C					
1/2" superflexible corrugated	R170 031 107		1	31.7	12.60	-	Yes	Silver / BBR	50	Solder type
Hand formable cable .141"	R170 031 007		2	22	3.65	1.05				
1/2" superflexible corrugated	R170 031 207		3	42	-	-			Clamp type	

RIGHT ANGLE PLUG



Cable group	Cable group dia.	Part number		Dimensions			Captive center contact	Finish	Packaging
				A	B	C			
RG402	Hand formable cable .141"	R170 152 107		19	16	12.5	Yes	Silver / BBR	50

SQUARE FLANGE STRAIGHT JACK

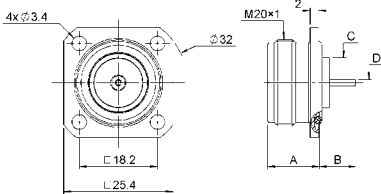

Part number		Dimensions				Captive center contact	Finish	Packaging
		A	B	C	D			
R170 413 127		12	8.5	11.5	1.5	Yes	Silver / BBR	50

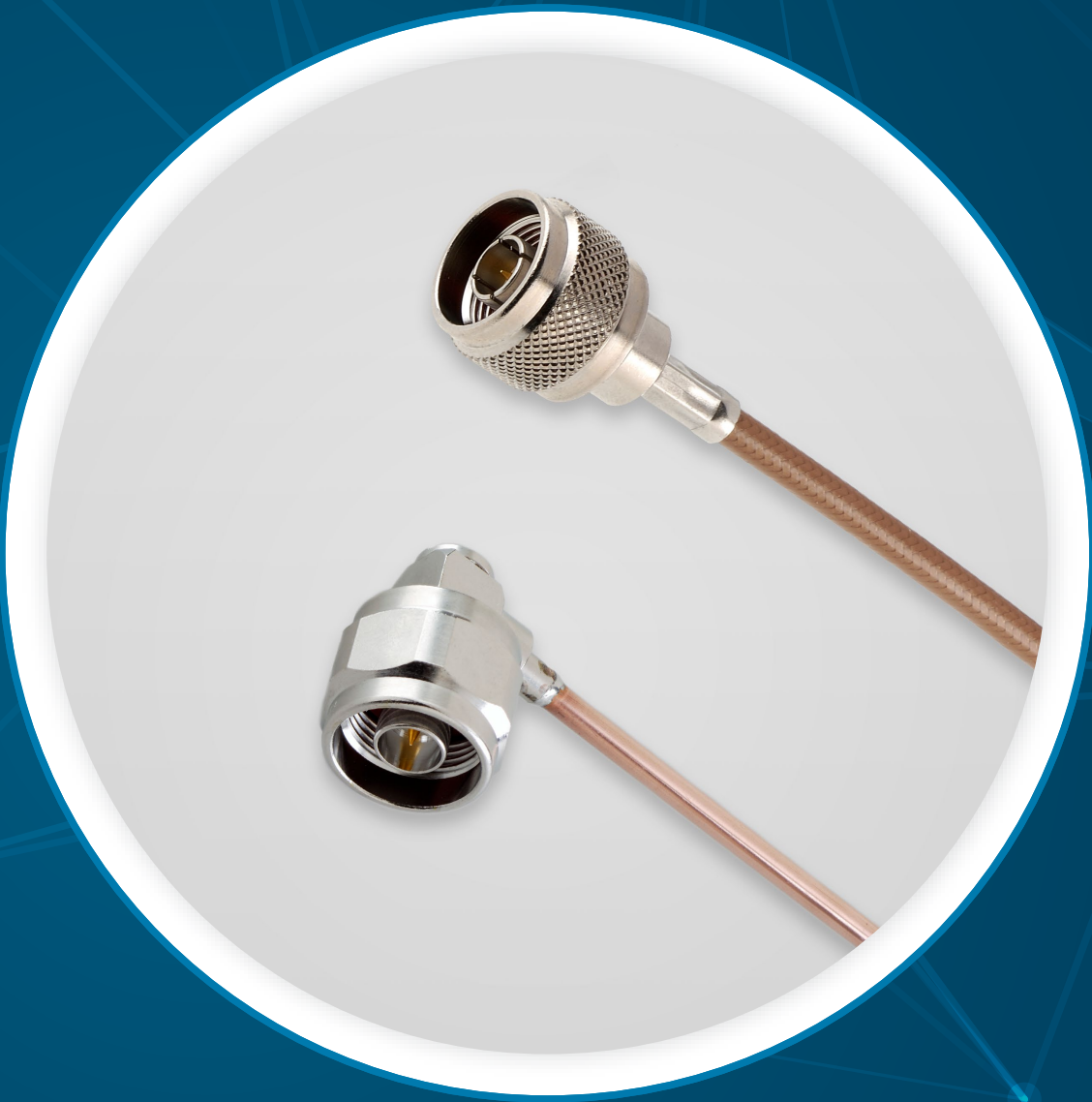

N SERIES

R161

Contents

N

Introduction.....	4-4 to 4-5
Characteristics	4-6 to 4-7
Plugs	4-8 to 4-9
Jacks	4-10 to 4-12
Receptacles.....	4-13 to 4-16
Accessories.....	4-17
Tools	4-17
Panel drilling	4-18
Terminations and attenuators.....	4-19 to 4-21

SECTION 4 TABLE OF CONTENTS

Introduction



50Ω

DC - 11 GHz (standard N)
DC - 18 GHz (N 18 GHz)

GENERAL

- Standard coaxial connectors
- Screw-on coupling
- High durability and proven strength
- High power rating
- Excellent RF performance

APPLICATIONS

- Wireless communications
- Civil and military radio-telecommunication equipment
- Countermeasure
- Navy equipment
- Industrial applications

APPLICABLE STANDARDS

- MIL-C-39012 / MIL STD 348-304
- CEI 169-16
- CECC 22210
- NF-C-93566
- DS 8811

COMPOSITE AND SWITCHING CONNECTORS

FULL CRIMP MODELS

This reliable attachment system can be easily installed in a field environment, with easy-to-use tooling (including models for 2 and 2.6 mm dia cables). All our full crimp connectors are single piece body.

18 GHz PRECISION CONNECTORS

These connectors are suitable for medium to high power applications and precision microwave test equipment. They have long life duration and enhanced electrical performance in severe environmental conditions. N18 series mate with all 50 ohms N connectors.

LOW INTERMODULATION CONNECTORS

Radiall extensive knowledge in this field led to the development of N series connectors that are specially designed for base stations of applications where the elimination of intermodulation products is of the utmost importance. Features:

- Optimized for 900 - 1800 MHz bands (and able to work up to 11 GHz like the standard models)
- IMP_3 performance = -110 dBm (-153 dBc)
- New models for corrugated and low loss flexible cables
- High performance non magnetic materials and platings (silver and BBR)
- New 6 flats coupling nut (18 mm), allowing high coupling torque (170 Ncm) thanks to torque wrench
- Non slotted outer contact

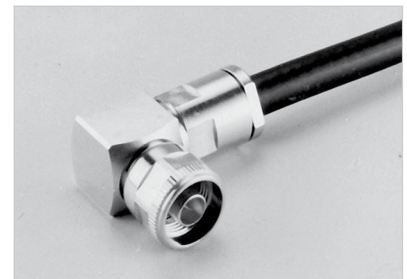
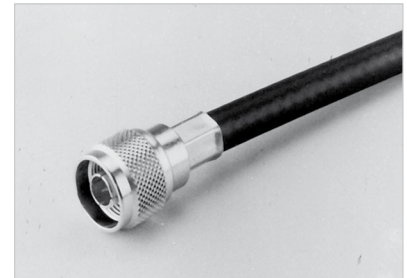
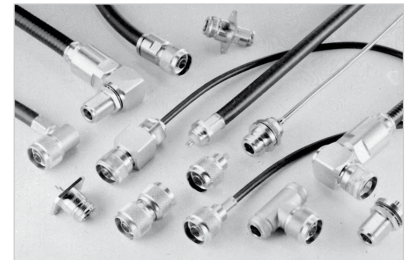

Introduction

Radiall offers a wide range with a standard plating finish: **BBR (Bright Bronze Radiall)** a high performance non-magnetic alloy.

VERY LOW INTERMODULATION CABLE ASSEMBLIES

For severe intermodulation conditions, we propose a range of low intermodulation cable assemblies $IMP3 \leq 125$ dBm.

For further details, reference:

- Intermodulation application guide (**D1 032 DE**)
- BBR plating application guide (**D1 030 DE**)

IMPORTANT: The 50 Ω and the 75 Ω connectors are NOT INTERMATEABLE and results in the destruction of the interface.

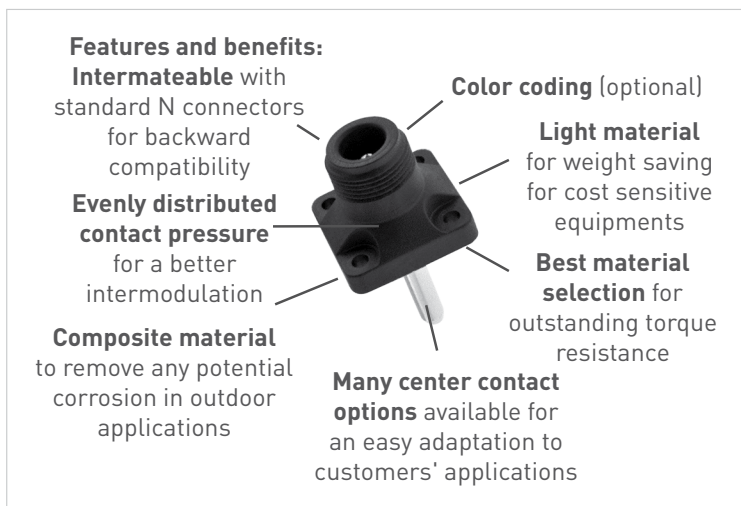

COMPOSITE RECEPTACLES

Radiall introduces its new composite N receptacles. Composite N connectors offer outstanding electrical performance and are the best compromise in terms of weight, cost and mechanical characteristics to replace existing brass technology.

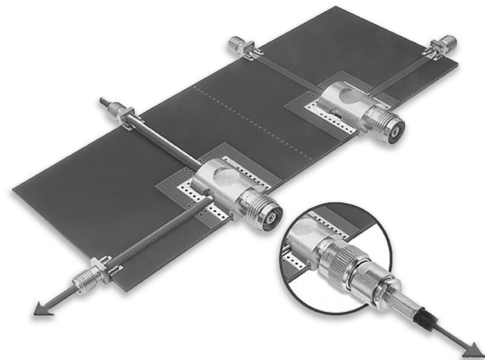

POWER SWITCHING CONNECTORS

This "two-in-one" solution replaces the existing standard RF switches by integrating the switch function into a receptacle connector. This solution provides a unique means of switching between two RF signal paths. As user friendly as a standard connector, the switch is mechanically activated by mating and unmating the connector.

Advantages

- Reliable
- Increases the density
- Excellent electrical and mechanical performance
- Reduction of the cost of ownership
- Betty RF adaptation
- Good isolation
- Available in right or left versions

Applications

- Telecom applications
- RF power amplifiers

PLATING

Radiall offers a wide range with a standard plating finish: **BBR (Bright Bronze Radiall)** a high performance non-magnetic alloy.

Characteristics

Test / Characteristics	Standard reference	Values / Remarks
------------------------	--------------------	------------------

ELECTRICAL CHARACTERISTICS

Test / Characteristics	Standard reference	Values / Remarks
Impedance		50Ω
Frequency range		DC - 11 GHz
Typical V.S.W.R.		1 GHz 2.5 GHz 5 GHz 11 GHz
• Straight models cable group:		
.085"		1.03 1.03 1.05 1.08
.141"		1.03 1.05 1.05 1.08
.250"		1.03 1.03 1.05 1.07
5/S+5/D		1.05 1.06 1.1 1.16
10/S+11/D		1.04 1.05 1.09 1.2
• Right angle models:		
5/S+D		1.04 1.05 1.18
10/S+11/D		1.04 1.1 1.20
Intermodulation product (IMP ₃)		- 90 dBm typ. [- 133 dBc typ. / 20W] - 110 dBm typ. [- 153 dBc typ. / 20W] - 125 dBm typ. [- 165 dBc typ. / 20W]
• Standard connectors		
• Intermodulation connectors		
• Home made intermodulation cable assemblies		
Insertion loss	MIL	< 0.15 dB max at 10 GHz ~ < 0.05 √F (GHz) < 0.15 dB max at 10 GHz ~ < 0.1 √F (GHz)
• Straight connector		
• Right-angle connector		
RF leakage	MIL	-90 dB min from 2 to 3 GHz (interface)
Insulation resistance	MIL	5000 MΩ min
Contact resistance	MIL	Initial After tests 1 mΩ 1.5 mΩ 0.2 mΩ -
• Center contact		
• Outer contact		
Working voltage in VRMS	CECC	Cable 5/50 850 (250) Cable .085"/.141" 350 (250) Cable 10+11/50 1400 (400) Cable LMR 400/600 1400 (400) Cable .250" 1400 (400)
• At sea level		
(at 70, 000 feet)		
Dielectric withstanding voltage in VRMS	CECC	Cable 5/50 1500 (350) Cable .085"/.141" 1000 (350) Cable 10/50 2500 (600) Cable LMR 400/600 2500 (600) Cable .250" 2500 (600)
• At sea level		
(at 70, 000 feet)		
RF testing voltage	CECC	1500 VRMS (5 MHz sine wave)
Sea level		

MECHANICAL CHARACTERISTICS

Test / Characteristics	Standard reference	Values / Remarks
Durability	CECC	500 matings
Engagement and separation torque	CECC	6.6 Ncm max (.58 Inch-pounds)
Recommended coupling nut torque		40 to 60 Ncm (manual) 130 Ncm (11.45 inch pounds) (with pliers R 282 202 000) 170 Ncm (14.96 inch pounds) (with torque wrench R 282 303 020)
Proof torque	CECC	170 Ncm (14.96 inch pounds)
Coupling nut retention force	CECC	450 N (101.25 Lbs)
Cable retention force	CECC	Cable 5/50/S 150N (33.75 Lbs) Cable 5/50/D 200N (48 Lbs) Cable 10/50 300N (67.5 Lbs) Cable 11/50 400N (90 Lbs) Cable .141" 270N (60.75 Lbs)
Center contact retention force	MIL	27 N (6.08 Lbs) cables < 8 mm 68 N (15.30 Lbs) cables > 8 mm
Axial		

Characteristics

Test / Characteristics	Standard reference	Values / Remarks
------------------------	--------------------	------------------

ENVIRONMENTAL CHARACTERISTICS

Temperature range	<ul style="list-style-type: none"> Standard models Semi-rigid cables 	CECC	- 55°C + 155°C - 55°C + 105°C
Thermo cycling test		CECC	- 55°C/+ 155°C/21 j
Thermal shock		CECC	- 40°C/+ 155°C or - 40°C/+ 85°C - 5 cycles
High temperature test		CECC	125°C/1000 H
Corrosion salt spray		CECC	48H (Possible 720H with HEP2R*)
Vibration		CECC	Sinus 10g/10 – 500 Hz
Shock		CECC	1/2 Sinus 50g/11 ms
Moisture resistance	<ul style="list-style-type: none"> Clamp type Crimp type 	IEC 529	IP 67 IP 65 (with heatshrink sleeve)
Hermetic test		CECC	10 ⁻⁵ bar. cm ³ /s
Leakage		CECC	Differential pressure 100 to 110 KPa: 1 bar cm ³ / H

MATERIALS

Body / nut / center male contact / outer contact	Brass
Center female contact	Treated beryllium copper
Ferrule	Brass
Insulator	PTFE
Gasket	Silicon elastomer

PLATING

	Standard	Intermodulation models + COAXI-KIT
Body	<ul style="list-style-type: none"> Crimp + clamp type Solder type 	Silver + BBR Silver
Outer contacts / design	BBR/cross knurled	BBR/hex.
Center contacts	Gold	Silver
Outer contacts / design	BBR/slotted	Silver + BBR/non slotted

PACKAGING

Packaging	50 pieces bulk Unit packaging
-----------	----------------------------------

*Contact us

Plugs

STRAIGHT PLUGS, CRIMP TYPE, FOR FLEXIBLE CABLES (single piece body)

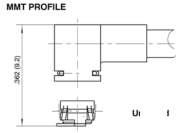

Fig. 1

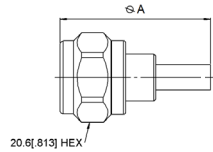

Fig. 2

Cable group	Cable group dia.	Part number	Fig.	Dimensions (mm)		Captive center contact
				A		
RG174 / RG316 / RD316 / AEP-100FR	2.6/50/S+D & LMR® 100	R161 072 000		1	39.7	Yes
AEP-195FR	LMR® 195	R161 082 120		2	38.5	
AEP-200FR	LMR® 200	R161 082 200		1	38.5	
AEP-240FR	LMR® 240	R161 075 030		2	38.5	
AEP-400FR	LMR® 400	R161 088 180			40.1	

STRAIGHT PLUGS, FOR SEMI-RIGID CABLES

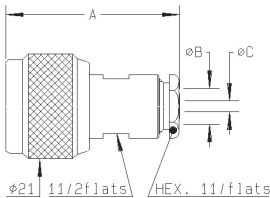

Fig. 1

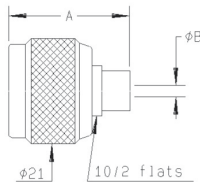

Fig. 2

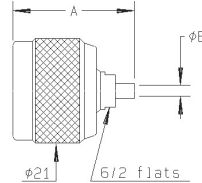





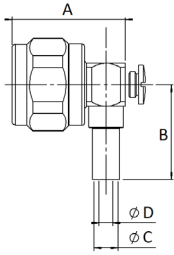



Fig. 3

Cable group	Cable group dia.	Part number	Fig.	Dimensions (mm)			Captive center contact	Note
				A	B dia.	C dia.		
RG405	.085"	R161 050 300		3	24.4	2.25	No	Solder type
RG402	.141"	R161 051 000				3.65		
		R161 052 000		1	35	5.6	3.65	Clamp type
RG401	.250"	R161 053 000		1	35.4	6.6	No	Clamp type
		R161 054 000		2	24.4	6.45		

Plugs

RIGHT ANGLE PLUGS, CRIMP TYPE, FOR FLEXIBLE CABLES



Cable group	Cable group dia.	Part number	Dimensions (mm)				Captive center contact	
			A	B	C dia.	D dia.		
AEP-200FR	LMR® 200	R161 182 080		26.3	22	5.55	3.25	Yes
AEP-240FR	LMR® 240	R161 183 310		26.3	24	6.6	4.05	
AEP-400FR	LMR® 400	R161 184 080		27	33	11.05	7.46	
AEP-600FR	LMR® 600	R161 188 200		31.7	39.1	15.88	11.96	

RIGHT ANGLE PLUG, SOLDER TYPE, FOR SEMI-RIGID CABLES

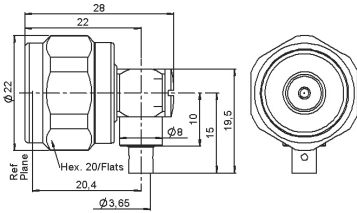

Cable group	Cable group dia.	Part number	Captive center contact
RG402	.141"	R161 152 107	 Yes

Jacks

STRAIGHT JACKS

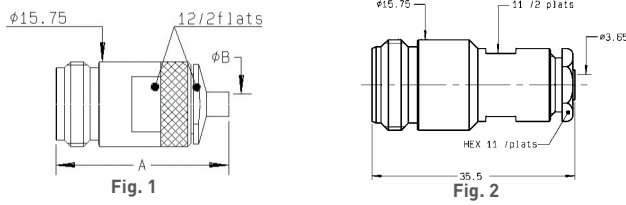

Cable group	Cable group dia.	Part number	Fig.	Dimensions (mm)		Captive center contact	Note	
				A	B dia.			
RG402	.141"	R161 226 020		1	32	3.65	No	Solder type
		R161 227 000		2				Clamp type

SQUARE FLANGE, STRAIGHT JACKS

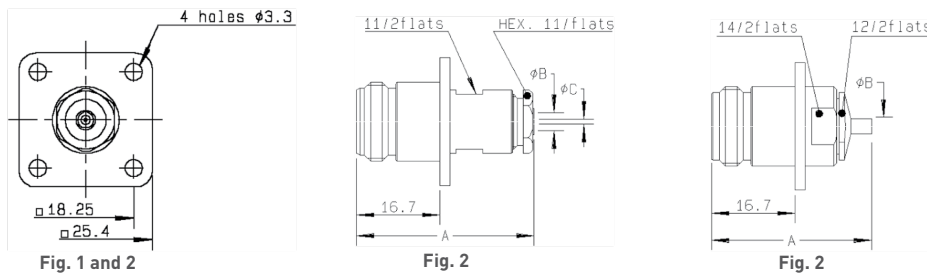

Cable group	Cable group dia.	Part number	Fig.	Dimensions (mm)			Captive center contact	Panel drilling	Note
				A	B dia.	C dia.			
RG402	.141"	R161 277 000		1	35.5	5.6	3.65		Clamp type
		R161 277 300		2	32	3.65		No	P11
RG401	.250"	R161 278 000		1	35.9	6.6			Clamp type

Jacks

**BULKHEAD STRAIGHT JACKS, FULL CRIMP TYPE, FOR FLEXIBLE CABLES
(panel sealed) (single piece body)**

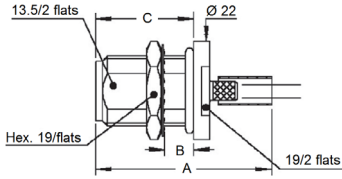

Cable group	Cable group dia.	Part number		Dimensions (mm)			Captive center contact	Panel drilling	Note
				A	B	C			
AEP-200FR	LMR® 200	R161 329 130		39.8	6.5	22.2	Yes	P01	Rear mount
AEP-240FR	LMR® 240	R161 329 140		37.8					
AEP-400FR	LMR® 400	R161 331 060		40.6		22			
AEP-600FR	LMR® 600	R161 331 400		49.9		23.7			

Jacks

BULKHEAD STRAIGHT JACKS, FOR SEMI-RIGID CABLES (panel sealed)

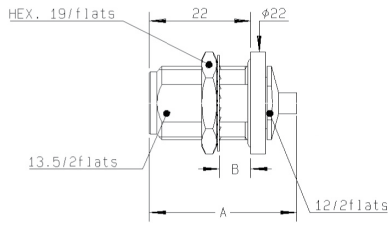

Fig. 1

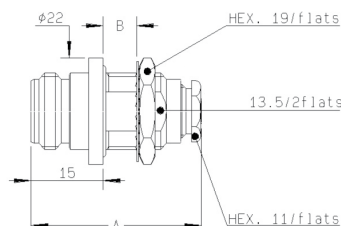

Fig. 2

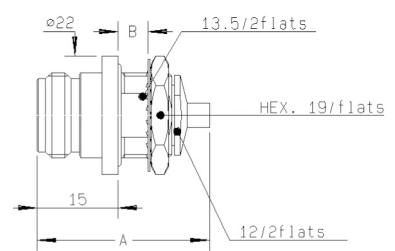

Fig. 3

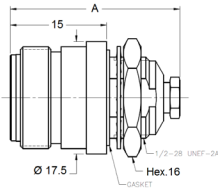







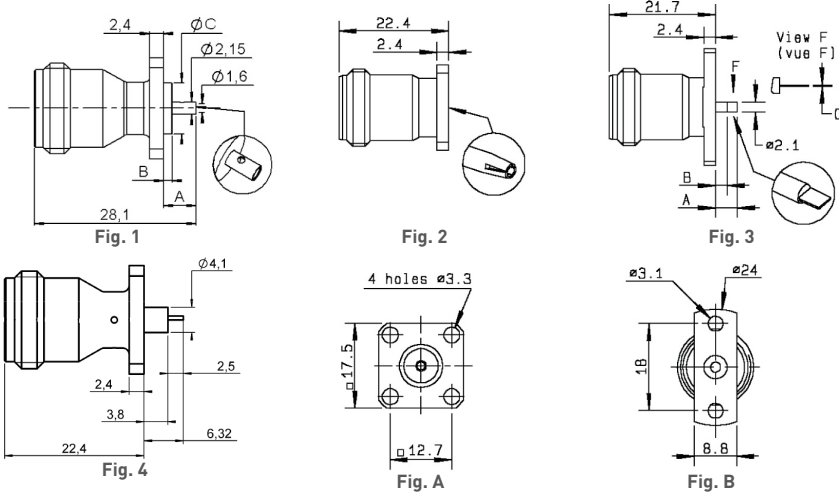



Fig. 4

Cable group	Cable group dia.	Part number	Fig.	Dimensions (mm)		Captive center contact	Panel drilling	Note
				A	B			
RG405	.085"	R161 335 200		1	32	6.5		Solder type/ Rear mount
RG402	.141"	R161 323 000		2	35.5	8		Clamp type/ Front mount
		R161 336 000		1			P11	Solder type/ Rear mount
		R161 336 200		3	32	6.5	No	Solder type/ Front mount
		R161 337 200		1				Solder type/ Rear mount
RG405	.085"	4502-7041-010		4	26.56			Solder type/ Front mount
RG402	.141"	4502-7041-009						
		4501-9543-009		1	33.52		Yes	Solder clamp/ Rear mount

Receptacles

FLANGE, STRAIGHT FEMALE RECEPTACLES



Part number	Fig.	Dimensions (mm)			Captive center contact	Panel drilling	Note	
		A	B	C				
R161 410 000		1 + A	5.7	1.5	8.9	P03		
R161A 410 000							ECO version	
R161 410 130		4 + A				Yes	P12	Solder pot contact
R161 418 000		2 + A					P03	Universal/See contacts page 12-22
R161 461 000		3 + B	6.2	3.9	0.6		P09	2 hole flange/Flat tab contact

Receptacles

STRAIGHT MALE AND FEMALE RECEPTACLES

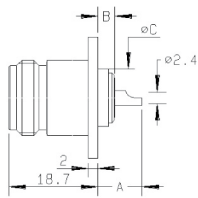

Fig. 1

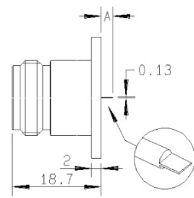

Fig. 2

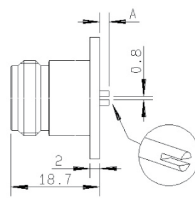

Fig. 3

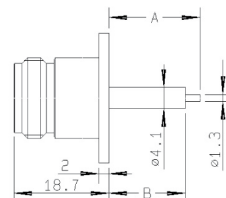

Fig. 4

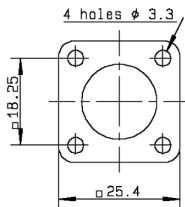

Fig. A

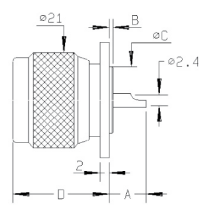

Fig. 5

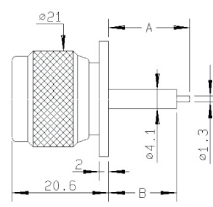

Fig. 6

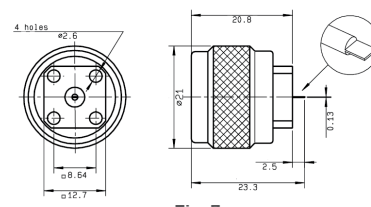
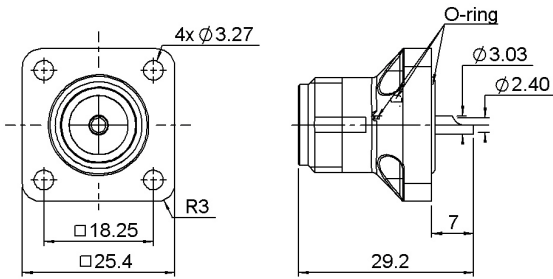

Fig. 7

Part number	Fig.	Dimensions (mm)				Captive center contact	Panel drilling	Note	
		A	B	C dia	D				
R161 404 000		1 + A	9.3	0.8	14.6	Yes	P05	Solder pot	
R161A 404 000								Solder pot/ECO version	
R161 404 137								For intermodulation application/ Center contact brass	
R161 416 130		4 + A	17.9	15	P06		Extended dielectric		
R161 419 020		2 + A	2.5		P07		Flat tab contact		
R161 419 300		3 + A	2		P01		Slotted contact		
R161 441 000		5 + A	8.7	0.8	14.6		20.6	P02	Male/Solder pot
R161 441 400		6 + A	17.9	15			P04	Male/Extended dielectric	
R161 438 200		7				P08			

Receptacles

COMPOSITE FEMALE RECEPTACLES



Part number	Captive center contact	Description	Color	Packaging
R161 404 C01		-		
R161 404 C02	Yes	Combination seal	Black	50 pieces
R161 404 C03		Panel seal		



Available upon request. Processed according to customer needs.

RIGHT ANGLE FEMALE RECEPTACLE

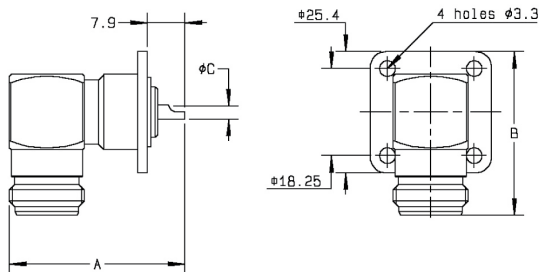

Part number	Dimensions (mm)			Captive center contact	Panel drilling	Note
	A	B	C dia			
R161 653 000	36.9	34.4	2.5	Yes	P02	Solder pot



Receptacles

BULKHEAD STRAIGHT RECEPTACLES (fully sealed or panel hermetic)

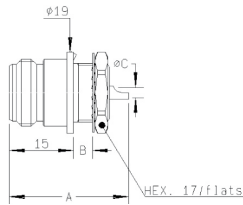

Fig. 1

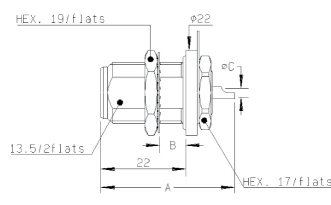

Fig. 2

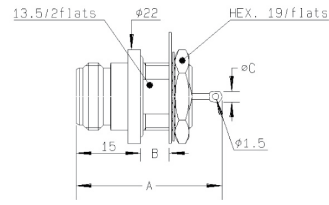



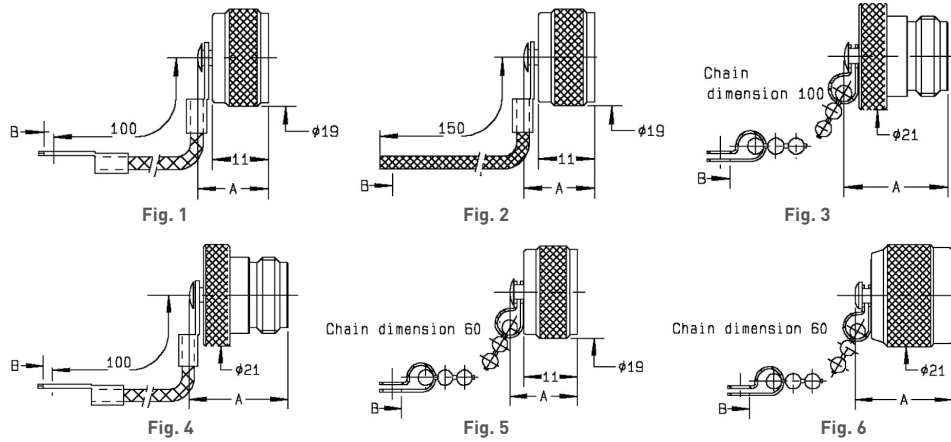

Fig. 3

Part number	Fig.	Dimensions (mm)			Captive center contact	Panel drilling	Note	
		A	B	C				
R161 570 000		1	28	4.5	2.4		P10	Front mount
R161 606 000		2	34.6	6.5	2.4	Yes	P11	Rear mount/Fully sealed
R161 625 000		3	34	6.5	2.5			Front mount/Panel hermetic

Accessories

PROTECTIVE CAPS



Part number	Fig.	Dimensions (mm)		Note
		A	B	
R161 804 000	1	13.9	3.8	Male with cord
R161 805 410	2	13.9	2	Male with cord
R161 841 000	3	20.4	3.9	Female with chain
R161 844 000	4	20.4	3.8	Female with cord
R161 853 000	5	13.9	3.9	Male with chain
R161 862 000	6	20.1		Male short circuit with chain

Tools

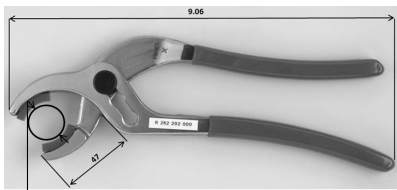
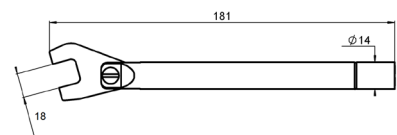

Fig. 1



Part number	Fig.	Description
R282 202 000	1	Pump pliers
R282 303 020	2	Torque wrench 18.0mm 170cm.N

Panel Drilling

P01

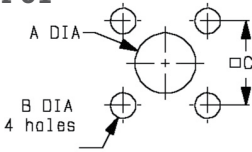

	MM		INCH	
	maxi	mini	maxi	mini
A	16.3	16.1	0.642	0.634
B	3.30	3.20	0.13	0.126
C	18.35	18.15	0.722	0.715

P02

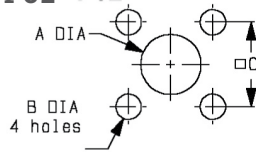

	MM		INCH	
	maxi	mini	maxi	mini
A	15.1	14.9	0.594	0.587
B	3.30	3.20	0.13	0.126
C	18.35	18.15	0.722	0.715

P03

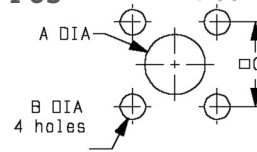

	MM		INCH	
	maxi	mini	maxi	mini
A	9.40	9.20	0.37	0.362
B	3.30	3.20	0.13	0.126
C	12.8	12.6	0.504	0.496

P04

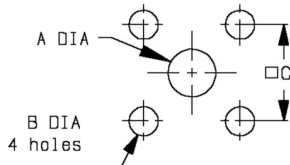

	MM		INCH	
	maxi	mini	maxi	mini
A	4.2	4.1	0.165	0.161
B	3.3	3.2	0.13	0.126
C	18.35	18.15	0.722	0.715

P05

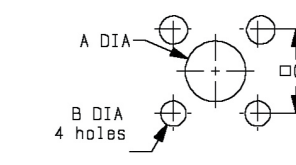

	MM		INCH	
	maxi	mini	maxi	mini
A Front	16.3	16.1	0.642	0.634
A Rear	15.1	14.9	0.594	0.587
B	3.30	3.20	0.13	0.126
C	18.35	18.15	0.722	0.715

P06

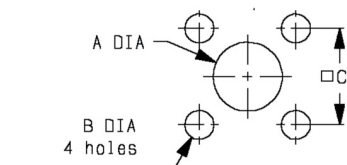

	MM		INCH	
	maxi	mini	maxi	mini
A Front	16.3	16.1	0.642	0.634
A Rear	4.2	4.1	0.165	0.161
B	3.3	3.2	0.13	0.126
C	18.35	18.15	0.722	0.715

P07

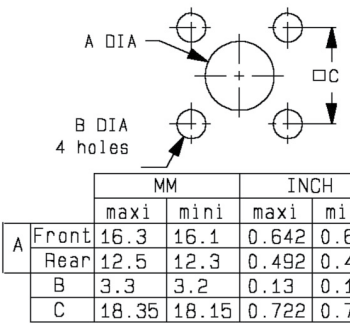

	MM		INCH	
	maxi	mini	maxi	mini
A Front	16.3	16.1	0.642	0.634
A Rear	12.5	12.3	0.492	0.484
B	3.3	3.2	0.13	0.126
C	18.35	18.15	0.722	0.715

P08

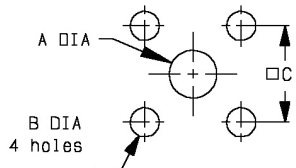

	MM		INCH	
	maxi	mini	maxi	mini
A	4.2	4.1	0.165	0.161
B	2.7	2.6	0.106	0.102
C	8.69	8.59	0.342	0.338

P09

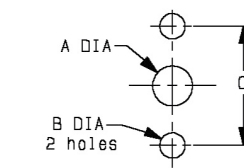

	MM		INCH	
	maxi	mini	maxi	mini
A	5	4.80	0.197	0.189
B	3.30	3.20	0.13	0.126
C	18.1	17.9	0.713	0.705

P10

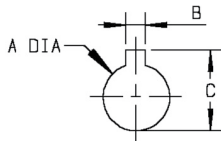

	MM		INCH	
	maxi	mini	maxi	mini
A	14.3	14.1	0.563	0.555
B	2.30	2.20	0.091	0.087
C	17	16.8	0.669	0.661

P11

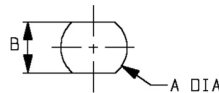

	MM		INCH	
	maxi	mini	maxi	mini
A	16.1	16	0.634	0.63
B	13.7	13.6	0.539	0.535

P12

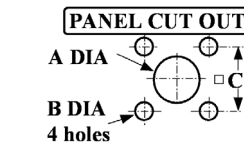

	mm		inch	
	Maxi	mini	Maxi	mini
A	4.25	4.15	0.167	0.163
B	3.4	3.2	0.133	0.125
C	12.8	12.6	0.503	0.496

Low Power Terminations

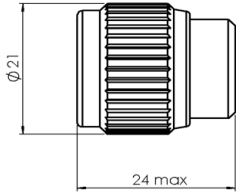

Fig. 1

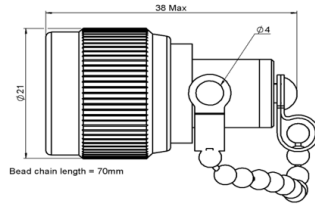

Fig. 2

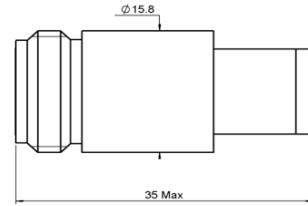





Fig. 3

Frequency DC to (GHz)	VSWR max.	Return loss min. (dB)	Power rating (W)		Impedance (Ω)	Gender	Part number		Fig.
			average	peak					
4	1.2	20.8	1	500	50±2%	Male	R404 131 000		1
4	1.2	20.8	1	500	50±2%	Male	R404 131 120 ⁽¹⁾		2
4	1.2	20.8	1	500	50±2%	Female	R404 132 000		3

(1) with bead chain

Medium Power Terminations

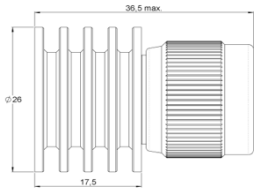

Fig. 1

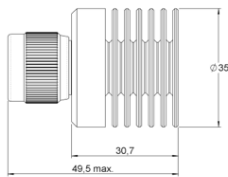

Fig. 2

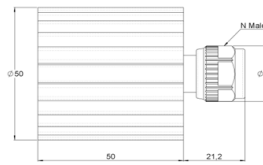

Fig. 3

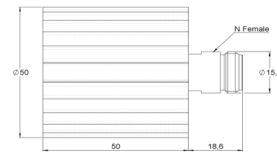





Fig. 4

Frequency DC to (GHz)	VSWR max.	Return loss min. (dB)	Power rating (W)		Impedance (Ω)	Gender	Part number		Fig.
			average	peak					
2	1.1	26.4	6	4000	50±5%	Male	R404 507 000		1
2	1.1	26.4	12	4000	50±5%	Male	R404 557 000		2
6	1.3	17.7	30	2000	50±5%	Male	R404 750 000		3
6	1.3	17.7	30	2000	50±5%	Female	R404 751 000		4

Low Power Attenuators

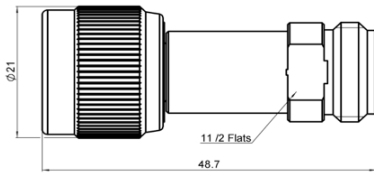

Fig. 1

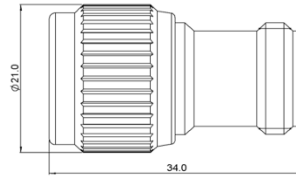



Fig. 2

Frequency DC to (GHz)	VSWR max.	Return loss min. (dB)	Power rating (W)		Nom. Attenuation (dB)	Max dev.	Part number	Fig.
			average	peak				
2	1.15	23.1	2	100	xx	± 0,35 (1)	R412 700 000	 1
Available attenuation value: xx = 00 to 15 step 1, 20, 30, 40 and 50 dB								
6	1.4	15.6	1	100	xx	± 0,5 (1)	R412 700 124	 2
Available attenuation value: xx = 00 to 20 dB step 1								

(1) up to xx = 15

Medium Power Attenuators

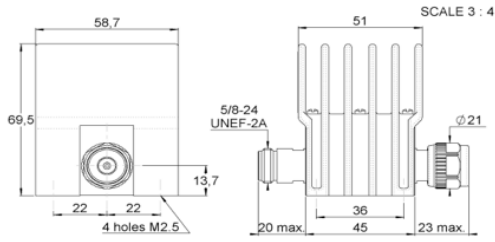

Fig. 1

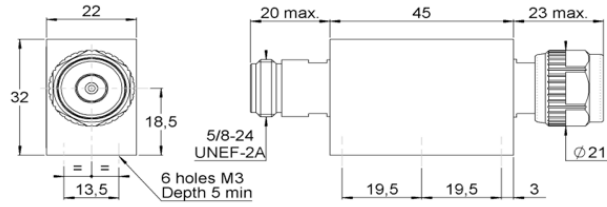

Fig. 2

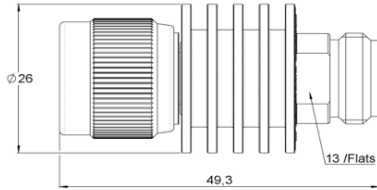





Fig. 3

Frequency DC to (GHz)	VSWR max.	Return loss min. (dB)	Power rating (W)		Nom. Attenuation (dB)	Max dev.	Part number	Fig.
			average	peak				
4	1.35	16.5	25	5000	xx	± 0,6 (1)	R417 303 110	 1
Available attenuation value: xx = 03, 06, 10, 20 and 30 dB								
4	1.35	16.5	30	5000	xx	± 0,6 (1)	R417 303 130	 2
Available attenuation value: xx = 03, 06, 10, 20 and 30 dB								
8	1.25	19.1	15 (2)	250	xx	± 0,3	R415 703 000	 3
Available attenuation value: xx = 03, 06, 10 and 20 dB								

[1] up to xx = 10

[2] 12 for xx = 06 , 10 for xx = 10 and 20



7/16 SERIES

R185

Contents

7/16

Introduction.....	5-4 to 5-5
Characteristics	5-6 to 5-7
Plugs	5-8
Jacks	5-8 to 5-9
Receptacles	5-10 to 5-11
Accessories and tools	5-12
Panel drilling	5-12
Terminations	5-13
Attenuators	5-14

SECTION 5 TABLE OF CONTENTS

Introduction

50Ω

DC - 7.5 GHz

GENERAL

- Standard coaxial connectors
- Screw-on coupling
- High power rating
- Excellent RF performance

APPLICABLE STANDARDS

- IEC 169-4
- DIN 47223
- CECC 22 190

APPLICATIONS

- Mobile communication infrastructure networks: combiner, diplexer, filter...
- Jumper and feeder cables assemblies
- Radio links
- Indoor and outdoor applications

Radiall's 7/16 series has been developed using the latest technology advances in connector design. These connectors are easy to use, highly reliable, innovative and designed to meet the needs of the telecommunications market. The complete connector series features:

- An extensive range, with optimized component part design
- An upgraded cross-knurled coupling nut allowing better manual tightening

Composite 7/16

Radiall expanded its line of innovative 7/16 composite connectors with jacks and receptacles as a lightweight, low cost alternative to brass connectors. Manufactured with corrosion-proof, composite materials these new single-piece connectors are UV resistant, meeting IEC 68-2-5 and IEC-68-2-9 to withstand all environments, including harsh outdoor installations. Radiall now offers over 20 different variations. The selection of the composite materials is a result of an in-depth competitive analysis of creeping speeds of zinc and aluminum alloys. Not only do the composite materials offer considerable performance advantages guaranteeing up to 500 matings, but with more than a 50% reduction in weight, this receptacle reduces the overall weight of the final module as well as transportation costs.

Introduction

High performance range

- Frequency range: DC - 7.5 GHz
- 2 types of coupling nut:
 - Cross-knurled and 6 flats 27mm wide coupling nut (3 000 N.cm)
 - 6 flats coupling nut (32mm wide), allowing high coupling torque (3 500 N.cm) when used with a torque wrench
- Intermodulation performance: 2 levels
 - 125 dBm cable assemblies
 - 110 dBm connectors and cable assemblies

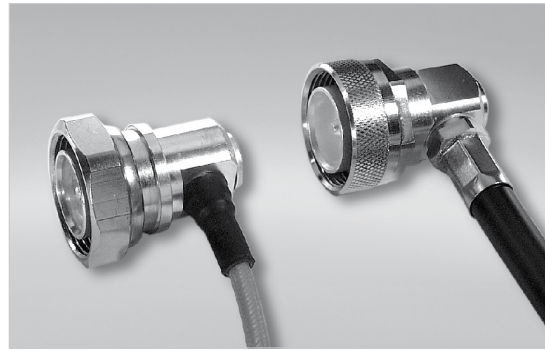

2 types of coupling nut

Radiall has developed its intermodulation measurement equipment following the IEC 46 D/292/NP standard proposal. It is aimed at third-order IMP measurements through the reflection method. The range of this test set-up is -132 dBm (-175 dBc) under 2 x 20 W.

- High performance non-magnetic material (brass) and plating (silver) with anti-tarnishing finish (strike of BBR)
- Non-slotted outer contact on standard products
- The 7/16 connector series benefits from a complete easy-to-use range of tooling



Custom models

To fulfill customer requirements, Radiall offers complete design of custom connectors according to the 7/16 series standard.

Characteristics

Test / Characteristics	Standard reference	Values / Remarks
------------------------	--------------------	------------------

ELECTRICAL CHARACTERISTICS

Impedance		50Ω			
Frequency range		DC - 7.5 GHz			
Typical V.S.W.R.		1 GHz	2.5 GHz	5 GHz	7.5 GHz
• Straight models		1.10 max from DC to 3 GHz - 1.20 max from 3 to 7.5 GHz			
RG213-RG214-RG393		1.04	1.06	1.08	1.10
.141"		1.04	1.07	1.08	1.20
.250"		1.03	1.05	1.11	1.13
1/2" superflexible corrugated		1.02	1.04	1.05	1.05
3/8" superflexible corrugated		1.03	1.03	1.12	1.20
1/4" superflexible corrugated		1.01	1.02	1.09	1.17
• Right angle models		1.15 max from DC to 3 GHz			
RG213-RG214-RG393		1.02	1.04	1.12	1.50
1/2" superflexible corrugated		1.04	1.04	1.14	1.60
3/8" superflexible corrugated		1.05	1.08	1.12	1.80
1/4" superflexible corrugated		1.02	1.06	1.13	1.60
Intermodulation product (IMP _c)		-110 dBm typ. [- 153 dBc typ / 20 W] -125 dBm typ. [- 168 dBc typ. / 20 W]			
• Connectors					
• Home made cable assemblies					
Insertion loss (dB)		0.05 √F (GHz)			
Straight connectors and right-angle connectors	MIL				
RF Leakage	CECC	130 dB at 1 GHz			
Insulation resistance	CECC	10 000 MΩ min			
Contact resistance		< 0.4 mΩ			
• Center contact	CECC	≤ 1.5 mΩ			
• Outer contact					
Working voltage in VRMS at sea level	CECC	2 700			
Dielectric withstanding voltage in VRMS		4 000			
• At sea level	CECC	350			
(at 70, 000 feet)					

MECHANICAL CHARACTERISTICS

Durability	CECC	500 matings
Force to engage and disengage	CECC	15 N
Recommended coupling nut torque		3 500 Ncm (with torque wrench R 282 303 500) 3 000 Ncm (with torque wrench R 282 303 520)
• Hex. coupling nut		
• Hex. + cross knurl coupling nut		
Proof torque	CECC	3 500 Ncm
Coupling nut retention force	CECC	1 000 N
Cable retention force		
Cable 5/50 & 10/50		250 N
Cable 1/4"	CECC	200 N
Cable 3/8"		250 N
Cable 1/2"		350 N
Cable 7/8"		500 N
Center contact retention force	CECC	200 N

ENVIRONMENTAL CHARACTERISTICS

Temperature range		- 55 °C + 155 °C - 55 °C + 105 °C
• Flexible cables and corrugated cables	CECC	
• Semi-rigid cables		
Thermo cycling test	CECC	- 55 °C / + 155 °C / 56 days
Rapid change of temperature	IEC	- 55 °C / + 155 °C / 5 cycles
High temperature test	CECC	1000 hours / 155 °C
Corrosion salt spray	IEC	48 hours / Na Cl 5% / 35 °C (Up to 720h with HEP2R)*
Vibration	CECC	98 m/s ² - 10 Hz at 500 Hz
Moisture resistance		IP67
• Clamp type	IEC 529	IP65 (with heatshrink sleeve)
• Crimp type		IP68 (overmolding)
• Home made cable assemblies		
Hermetic test	IEC	5 Pa. cm ³ /s
Leakage	CECC	1 cm ³ /h max

* Contact us

Characteristics

MATERIALS AND PLATINGS

	Materials	Plating
Bodies	Brass	Silver + BBR
Nut	Brass	BBR
Center contact • Male • Female	Brass Beryllium copper	Silver
Insulator	PTFE	
Gasket	Silicon rubber	

POWER RANGE

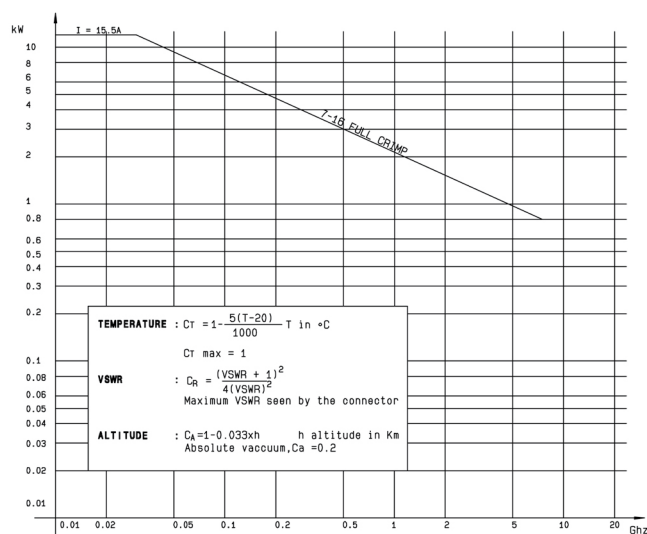

Characteristics Composite 7/16

ELECTRICAL CHARACTERISTICS

Frequency range	DC - 7.5 GHz
VSWR	1.06@DC-3 GHz - 1.10@DC - 3-7.5 GHz
High working voltage	> 2700 V
Very low intermodulation	IMP3 < -125 dBm under 2 carriers of +43dBm And typically < -130 dBm
Power handling	> 800 W@ 935 MHz

MECHANICAL CHARACTERISTICS

Longlife duration	up to 500 mating cycles
Coupling torque	35 Nm or less
Coupling strength	1000 N
Center contact retention / axial force	> 200 N
Center contact retention / torque	> 80 Ncm

ENVIRONMENTAL CHARACTERISTICS

Temperature range	-40°C / +85°C
Humidity	Up to 100% @ 20°C
Flammability rating	UL94-V0
UV resistance	IEC 68-2-5 / IEC 68-2-9
Waterproof	IP67

Plugs and Jacks

STRAIGHT PLUGS, FOR FLEXIBLE AND SEMI-RIGID CABLE

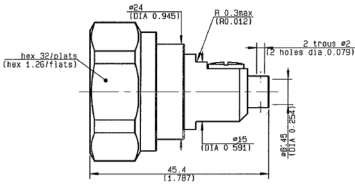

Fig. 1

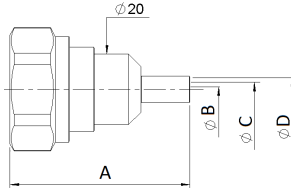



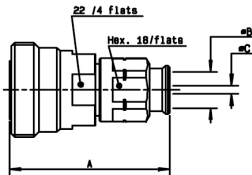

Fig. 2

Cable group	Cable group dia.	Part number	Fig.	Dimensions (mm)				Captive center contact	Finish	Note	
				A	B	C	D				
RG401	.250"	R185 054 020		1					Silver + BBR	Solder Type	
AEP-240FR	LMR® 240	R185 083 310		2	51.15	1.5	4.05	6.6	Yes	BBR	Clamp type
AEP-400FR	LMR® 400	R185 085 007			49.55	2.82	7.46	11.05			
AEP-600FR	LMR® 600	R185 077 010			58.05	4.7	11.96	15.88			

STRAIGHT JACKS



Cable group dia.	Part number	Dimensions (mm)			Captive center contact	Finish	Note
		A	B	C			
1/4" superflexible corrugated	R185 215 200	49.45	7.95	4.7	Yes	Silver + BBR	Clamp type
1/2" superflexible corrugated	R185 216 200	50	14	8.8			
3/8" superflexible corrugated	R185 217 200		11	7.1			

Jacks

STRAIGHT SQUARE FLANGE JACK

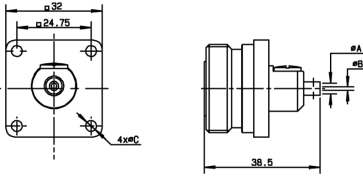

Cable group	Cable group dia.	Part number	Captive center contact	Dimensions (mm)			Panel drilling	Finish	Note
				A	B	C			
RG402	.141"	R185 252 000		Yes	3.65	0.996	3.6	P01	Silver + BBR Solder type for semi-rigid cables

STRAIGHT BULKHEAD JACKS FOR FLEXIBLE CABLES AND CORRUGATED CABLES

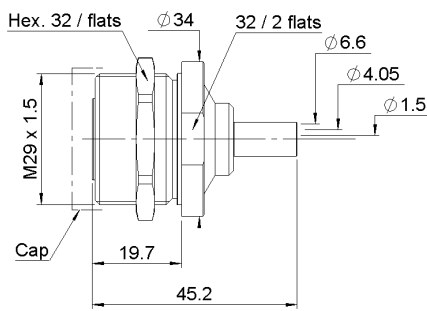

Fig. 1

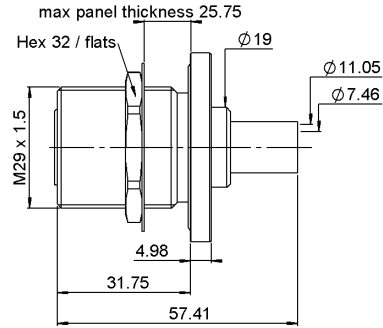

Fig. 2

Cable group	Cable group dia.	Part number	Fig.	Captive center contact	Panel drilling	Finish	Note
AEP-240FR	LMR® 240	R185 314 100		1	Yes	P02	BBR Clamp type
AEP-400FR	LMR® 400	R185 320 020		2			

Receptacles

STRAIGHT FLANGE FEMALE RECEPTACLES

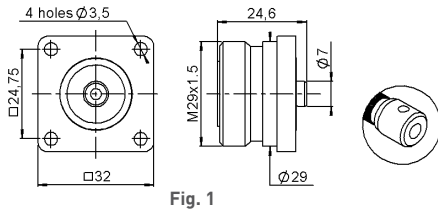

Fig. 1

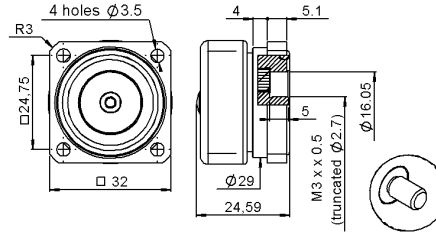

Fig. 2

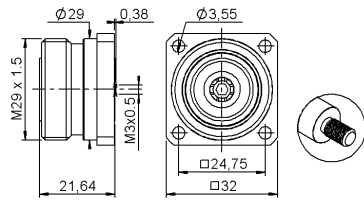

Fig. 3

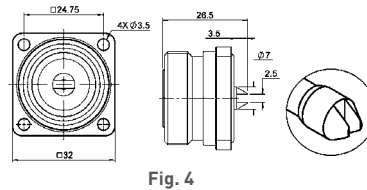

Fig. 4

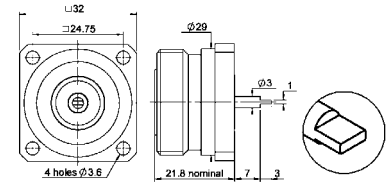





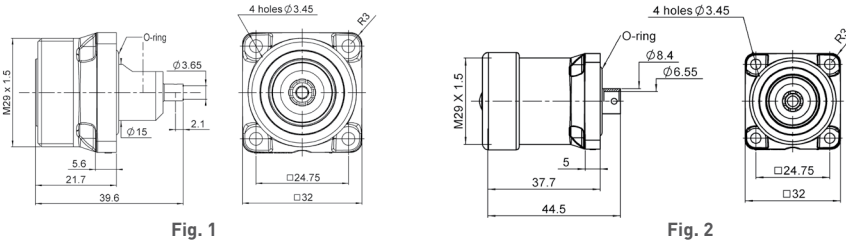

Fig. 5

Part number	Fig.	Captive center contact	Panel drilling	Finish	Slotted outer contact	Packaging	Note	
R185 403 547		1	P03	BBR	No	20	With solder pot contact	
R185 405 200		2		Silver + Copper	Yes		Panel seal flange mount	
R185 406 090		3		Yes	BBR		50	M3
R185 404 200		4			Silver + Copper	No	20	With slotted contact
R185 403 490		5		P04			20	With tab contact

Receptacles

SQUARE FLANGE JACK RECEPTACLE SOLDER TYPE, PANEL SEAL



Cable group	Cable group dia.	Part number		Fig.	Panel drilling
RG402	.141"	R187 403 010		1	P06
RG401	.250"	R187 130 000		2	

SQUARE FLANGE JACK RECEPTACLE PANEL SEAL

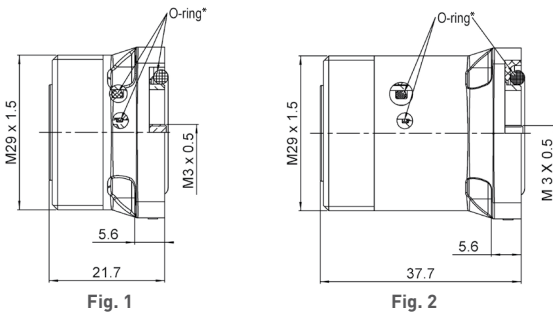

Part number	Fig.	Captive center contact	Waterproof interface	Color	Panel drilling
R187 403 000	1	No	No	Black	P06
R187 403 100			Yes		
R187 406 000		Yes	No		
R187 406 100			Yes		
R187 413 000	2	No	No		
R187 413 100			Yes		
R187 416 000		Yes	No		
R187 416 100			Yes		

Available packaged in increments of 20 units

Processed according to customer needs

* O-ring inside, only on the waterproof models

Accessories and Tools

PROTECTIVE CAP

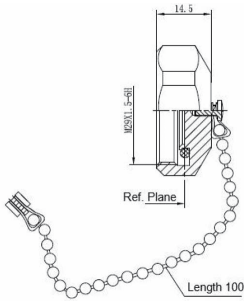

Part Number	Note
R185 812 007	Male with chain

TORQUE WRENCH 32mm

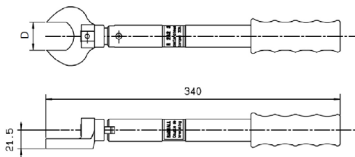

Part Number	Accross flats D (mm)	Coupling torque (N.cm)
R282 303 500	32 (1.260)	3500

Panel Drilling

P01

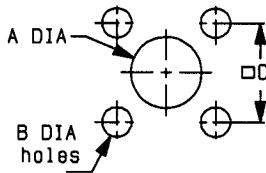

	MM		INCH	
	maxi	mini	maxi	mini
A	29.2	29.1	1.15	1.146
B	3.7	3.6	0.146	0.142
C	24.8	24.7	0.976	0.972

P02

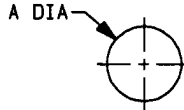

A	MM		INCH	
	maxi	mini	maxi	mini
A	29.2	29.1	1.15	1.146

P03

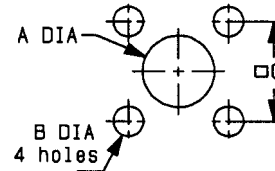

	MM		INCH	
	maxi	mini	maxi	mini
A (R. Mount)	16.2	16	0.638	0.63
A (F. Mount)	29.3	29.1	1.154	1.146
B	3.7	3.6	0.146	0.142
C	24.8	24.7	0.976	0.972

P04

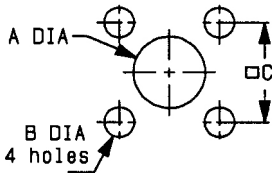

	MM		INCH	
	maxi	mini	maxi	mini
A	12.3	12.1	0.484	0.476
B	3.8	3.7	0.15	0.146
C	24.8	24.7	0.976	0.972

P05

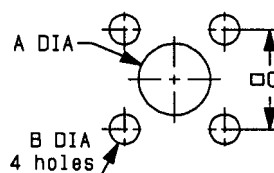

	MM		INCH	
	maxi	mini	maxi	mini
A	16.2	16	0.638	0.63
B	3.7	3.6	0.146	0.142
C	24.8	24.7	0.976	0.972

Low Power Terminations

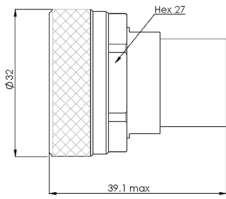

Fig. 1

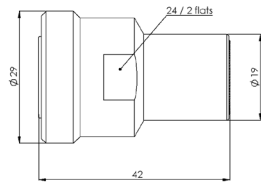



Fig. 2

Frequency DC to (GHz)	VSWR max.	Return loss min. (dB)	Power rating (W)		Impedance (Ω)	Gender	Part number	Fig.	
			average	peak					
4	1.15	23.1	2	500	50±5%	Male	R404 170 111		1
						Female	R494 175 111		2

Medium Power Terminations

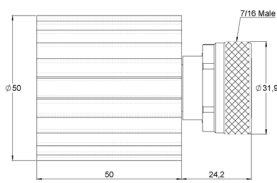

Fig. 1

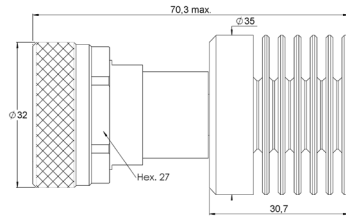

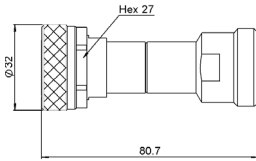



Fig. 2

Frequency DC to (GHz)	VSWR max.	Return loss min. (dB)	Power rating (W)		Impedance (Ω)	Gender	Part number	Fig.	
			average	peak					
6	1.3	17.7	30	2,000	50±5%	Male	R404 756 000		1
4	1.2	20.8	12	5,000			R494 564 000		2

Low Power Attenuators





Frequency DC to (GHz)	VSWR max.	Return loss min. (dB)	Power rating (W)		Nom. Attenuation (dB)	Max dev.	Part number	
			average	peak				
3	1.3	17.7	1	100	xx	±0,5 ⁽¹⁾	R412 806 000	

Available attenuation value: xx- 03, 06, 10 and 20 dB.

(1) ±1 for xx = 20

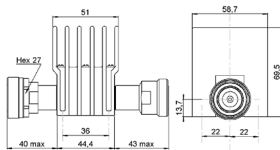
Medium Power Attenuators



Frequency DC to (GHz)	VSWR max.	Return loss min. (dB)	Power rating (W)		Nom. Attenuation (dB)	Max dev.	Part number	
			average	peak				
4	1.35	16.5	25	5,000	xx	±0,6 ⁽¹⁾	R420 303 110	

Available attenuation value: xx- 03, 06, 10 and 20 dB.

(1) ±0,6 for xx = 20



JUMPER SERIES

R296

Contents



Jumpers

Introduction 6-4 to 6-5

SECTION 6 TABLE OF CONTENTS



Introduction

As a prime supplier to the Telecommunications industry, Radiall introduces an expanded range of Low PIM cable jumpers. These cost competitive jumpers provide excellent electrical and mechanical performance to support the demanding needs of the wireless installation market.

FEATURES

- Excellent electrical and mechanical performance
- Low passive intermodulation (PIM)
- Low return loss
- High shielding effectiveness
- High flexibility and tight bending radius
- Waterproof - meets or exceeds IP67
- 100% tested for PIM, VSWR and IL
- Black LSZH PE Jacket
- 1/2" and 3/8" superflexible corrugated cable types (**)
- Available with 4.3-10, 7/16 and NEX10 connectors (**)

SPECIFICATIONS

- $50\Omega \pm 2\Omega$
- DC ~ 3GHz
- VSWR: 1.15 max.
- PIM3: $\leq -160\text{dBc}$ @ 1800MHz 2x20W
Static & dynamic conditions (IEC 62037-2)
- Static bending radius: 27mm (1/2") - 25mm (3/8") cables
- Mechanical endurance: 100 Cycles
- Temperature range: -40 to +85°C
- RoHS Compliant

** Other connector and cable styles available upon request.

Introduction

Radiall's low intermodulation cable jumper solutions are suitable for indoor or outdoor cabling to base stations and antenna systems.



4.3-10 Straight
Fig. 1



4.3-10 Right Angle
Fig. 2



7/16 Straight
Fig. 3



7/16 Right Angle
Fig. 4

Cable size	Connector 1	Fig.	Connector 2	Fig.	Part number
1/2" S	4.3-10 Straight	1	4.3-10 Straight	1	R296 702 807 xxx
	4.3-10 Straight		4.3-10 Right Angle	2	R296 702 808 xxx
	7/16 Straight	3	7/16 Straight	3	R296 702 811 xxx
	7/16 Straight		7/16 Right Angle	4	R296 702 812 xxx
3/8" Superflex	4.3-10 Straight	1	4.3-10 Straight	1	R296 702 809 xxx
	4.3-10 Straight		4.3-10 Right Angle	2	R296 702 810 xxx
	4.3-10 Straight		7/16 Straight	3	R296 702 815 xxx
	4.3-10 Straight		7/16 Right Angle	4	R296 702 816 xxx
	4.3-10 Right Angle	2	7/16 Straight	3	R296 702 817 xxx
	4.3-10 Right Angle		7/16 Right Angle	4	R296 702 818 xxx
	7/16 Straight	3	7/16 Straight	3	R296 702 813 xxx
	7/16 Straight		7/16 Right Angle	4	R296 702 814 xxx

Length (m)	xxx	IL (Db)	Length	xxx	IL
0.5 ±0.01	005	0.23	4.5 ±0.09	045	1.26
1.0 ±0.02	010	0.36	5.0 ±0.10	050	1.39
1.5 ±0.03	015	0.49	5.5 ±0.11	055	1.52
2.0 ±0.04	020	0.62	6.0 ±0.12	060	1.65
2.5 ±0.05	025	0.75	7.0 ±0.14	070	1.91
3.0 ± 0.06	030	0.88	8.0 ±0.16	080	2.17
3.5 ± 0.07	035	1.01	9.0 ±0.18	090	2.43
4.0 ± 0.08	040	1.14	10.0 ±0.20	100	2.69



ADAPTER SERIES

R191 / R192

Contents



Adapters

Adapters between series 7-4 to 7-6
Adapters in-series 7-7 to 7-9













SECTION 7 TABLE OF CONTENTS















Adapters Between Series

Interface A		Interface B		Part number	3D	
Series	Gender	Series	Gender			
4.1-9.5	Female	4.3-10	Male	R191 598 007		
4.3-10	Female	7-16	Male	R191 592 007		
			Female	R191 592 037		
		N	Male	R191 591 007		
		NEX10	Female	R191 620 037		
	Male	4.1-9.5	Female	R191 598 007		
			Female	R191 592 017		
		7-16	Male	R191 592 027		
			N	Female	R191 591 017	
	7-16	Female	4.3-10	Female	R191 592 037	
			4.3-10	Male	R191 592 017	
N			Female	R191 723 000		

Adapters Between Series

Interface A		Interface B		Part number	3D
Series	Gender	Series	Gender		
7-16	Female	N	Male	R191 720 000	
		4.3-10	Female	R191 592 007	
	Male	4.3-10	Male	R191 592 027	
		N	Female	R191 722 000	
		N	Male	R191 721 000	
		NEX10	Female	R191 620 017	
N	Female	4.3-10	Male	R191 591 017	
		7-16	Female	R191 723 000	
		7-16	Male	R191 722 000	
		NEX10	Male	R191 620 007	
		NEX10	Male	R191 630 007	
		NEX10	Female	R191 620 027	

Adapters Between Series



Interface A		Interface B		Part number	3D
Series	Gender	Series	Gender		
N	Male	4.3-10	Female	R191 591 007	
		7-16	Female	R191 720 000	
		7-16	Male	R191 721 000	
NEX10	Female	4.3-10	Female	R191 620 037	
		7-16	Male	R191 620 017	
		N	Female	R191 620 027	
		SMA 3.5	Male	R191 621 017	
	Male	N	Female	R191 620 007	
		N	Female	R191 630 007	
		SMA 3.5	Female	R191 621 007	
SMA 3.5	Female	NEX10	Male	R191 621 007	
	Male	NEX10	Female	R191 621 017	

Adapters in Series

7-16 SERIES



Part number	3D	Captive center contact	Finish	Note
R185 703 000		Yes	Silver + Copper	Male - Male
R185 705 000				Female - Female
R185 707 000				Male - Female
R185 710 000				Female - Female flange mount
R185 730 020			Silver + BBR	Female - Female

Adapters in Series**N SERIES**

Part number	3D	Note
R161 703 000		Male - Male
R161 705 000		Female - Female
R161 715 000		Female - Female / Flange
R161 730 000		Female - Female / Bulkhead panel sealed
R161 753 000		Female - Female / Hermetic / Bulkhead
R161 771 000		Push-on Male / Female screwing
R161 791 500		push-on male / female screwing
R161 791 530		Push-on Female / Male screwing

Adapters in Series

4.3-10

Part number	3D	Note
R183 703 007		Male - Male
R183 705 007		Female - Male
R183 707 007		Male - Male



RxF SERIES

R2F / R4F

Contents

RXF

Introduction..... 8-4
Characteristics 8-5
RXF product range 8-6 to 8-10
Accessories and tools..... 8-11

SECTION 8 TABLE OF CONTENTS

Introduction**RXF: RADIALL OUTDOOR FIBER OPTIC CONNECTOR**

Dedicated to outdoor optical connections, RXF is designed and manufactured by Radiall. RXF connectors are available with 2 and 4 channels, in MultiMode or SingleMode UPC versions.

RXF can be provided as a complete cable assembly or connector kit depending on customer needs. A quick-locking device with IP68 sealing and low loss insertion allows this connector to be used in severe outdoor connections and harsh environments.

APPLICATIONS

- Wireless communications
- Energy
- Transportation
- Monitoring display

International Standard Document Compliance

- IEC 61300 Fiber optic interconnecting devices and passive components
- Telcordia GR-326-CORE optical connectors and jumper assemblies
- IEC 60529 Degrees of protection provided by enclosures (IP code)
- EN 50125 Railway applications - environmental conditions for equipment
- MIL-PRF-39012 Standard N type mechanical interface
- RoHS compliant

Features and Benefits

- *Robust connection*
 - Fully protected ceramic ferrules and alignment sleeves: no risk to damage the optical faces during mounting/dismounting operations
 - Standard mechanical interface: N type screwing according to MIL-PRF-39012
 - Use of standard optical ferrules 1.25mm
- *Easy installation*
 - Qualified with other compatible outdoor fiber optic N type connectors
 - Screwed locking mechanism: easy to install (U-19mm wrench/1 N.m torque)
 - Fast and easy connection: one-hand blind mate coupling
- *Suitable for harsh environments (adapted for outdoor use)*
 - Waterproof connection
 - Dust proof
 - Corrosion resistant
- *High level of performance*
 - Full compliance to IEC 61300 standard
 - High tensile strength
 - EMI immunity

Characteristics

OPTICAL CHARACTERISTICS

Insertion loss (IEC 61300-3-4)	Typical ≤ 0.2 dB (max ≤ 0.5 dB)
Return loss	≥ 50 dB

Insertion loss against a reference patchcord: IEC 61300-3-4 Method B

Return loss: IEC 61300-3-6

Note: The optical performance also depends on the fiber or cable qualities.

MECHANICAL CHARACTERISTICS

Mating endurance	IEC 61300-2-2	500 mating cycles minimum
Tensile resistance	RXF Plug	800 N (with field cable)*
	RXF Socket	30 N (with field cable)*
Vibrations	IEC 61300-2-1	Passed
Shocks	IEC 61300-2-9	Passed

*Depending on cable type

ENVIRONMENTAL CHARACTERISTICS

Operating temperature range	IEC 61300-2-22	-40°C/+85°C
Salt spray	IEC 61300-2-26	Passed
Ingress protection class	IEC 60529	IP 68 (with screwed cap or when mated)

MATERIALS

Housing	Brass
Plating	Nickel



RXF Product Range

RXF PLUG KITS

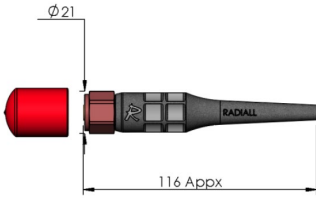

Fig. 1

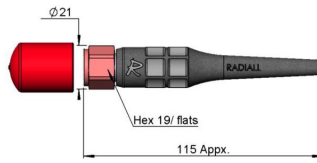

Fig. 2

Part number		Fiber type	Fig.	Dimensions (mm)	Channels
RXF2 130 500		Multi	1	5-5.6	2
RXF2 130 600				6	
RXF2 130 700				7	
RXF2 131 500				5-5.6	
RXF2 131 510				5-5.6	
RXF2 131 600				6	
RXF2 131 700				7	
RXF4 130 500		Multi	2	5-5.6	4
RXF4 130 700				7	
RXF4 131 500				Single	

RXF Product Range

RXF SOCKETS

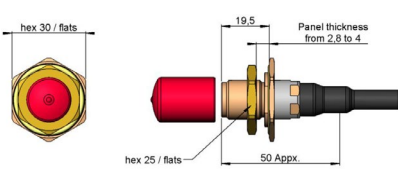

Fig. 1

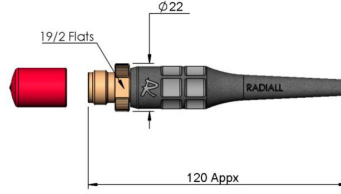

Fig. 2

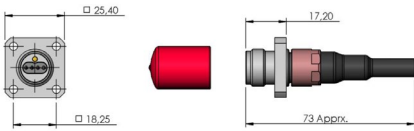

Fig. 3

Part number	Fiber type	Fig.	Dimensions (mm)	Channels
RXF2 330 500	Multi mode	2	5-5.6	2
RXF2 331 500	Single mode			
RXF2 430 200	Multi mode	3	25.4 x 25.4	2
RXF2 431 200	Single mode			
RXF4 230 200	Multi mode	1	30 on flats	2
RXF4 231 200	Single mode			
RXF4 330 500	Multi mode	2	5-5.6	4
RXF4 330 700	Multi mode		7	
RXF4 331 500	Single mode		5-5.6	
RXF4 430 200	Multi mode	3	25.4 x 25.4	2
RXF4 431 200	Single mode			

RXF Product Range

RXF PLUG KITS

Radiall can accommodate different types of cables (simplex or field cables) and various diameters. The cable assemblies will be customized to fit with particular application requirements (specific labeling, length, etc.) and will be tested before shipment. Radiall's assembly plants have mass production capacity and can adapt to low and high volume demands.

DEFINE YOUR CABLE ASSEMBLIES:

- 1 - Number of channels: R2F or R4F
- 2 - Connector end 1 + protective cap
- 3 - Connector end 2 + protective cap
- 4 - Fiber type and cable type
- 5 - Length

SELECT A CABLE ASSEMBLY AMONG STANDARD PART NUMBERS:

Radiall designs, manufactures and supplies standard outdoor cable assemblies. A standard configuration combines standard fiber optic connectors and cables with standard length and tolerances. Standard outdoor cable assemblies are catalog items with short lead times due to the direct availability of the components.

R2F Socket Square Flange to LC Duplex – Indoor Simplex Cable Ø2 mm

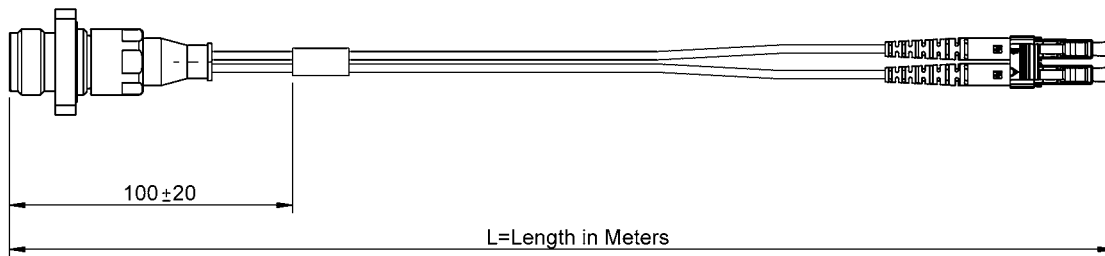

Fiber type	Part number	Length
SM 9/125 µm G652	F760 855 220	L=1 m
MM 50/125 µm OM2	F760 858 220	L=1 m

Note: Other lengths are available upon request.

R4F Socket Hexagonal to 2 x LC Duplex – Indoor Simplex Cable Ø2 mm

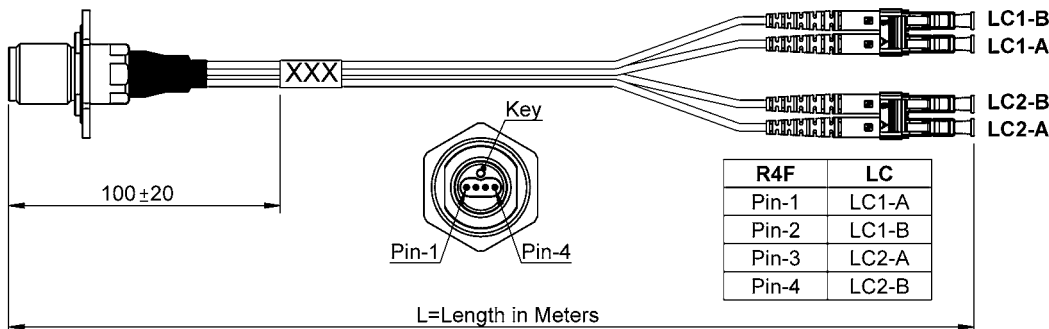

Fiber type	Part number	Length
SM 9/125 µm G652	F760 855 240	L=1 m
MM 50/125 µm OM2	F760 858 240	L=1 m

Note: Other lengths are available upon request.

RXF Product Range

R2F Plug to LC Duplex – Outdoor Field Cable Ø5 mm

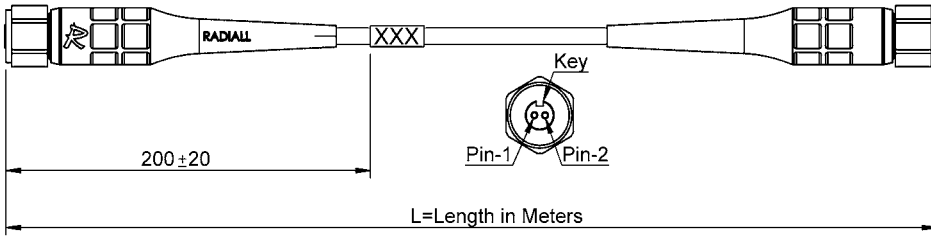

Fiber type	Part number (*)
SM 9/125 µm G652	F760 855 620-XX
MM 50/125 µm OM2	F760 858 620-XX

(*): replace “XX” by the length in meters
 Standard length: 5 m and 50 m
 Ex: F760 855 620-05 for 5 m



R2F Plug to R2F Plug – Outdoor Field Cable Ø5 mm

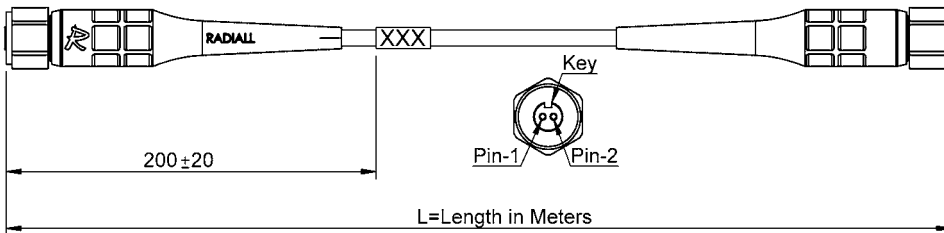

Fiber type	Part number (*)
SM 9/125 µm G652	F760 885 620-XX
MM 50/125 µm OM2	F760 888 620-XX

(*): Replace “XX” by the length in meters
 Standard length: 5 m and 50 m
 Ex: F760 885 620-05 for 5 m

RXF Product Range

R4F Plug to 2 x LC Duplex – Outdoor Field Cable Ø5 mm

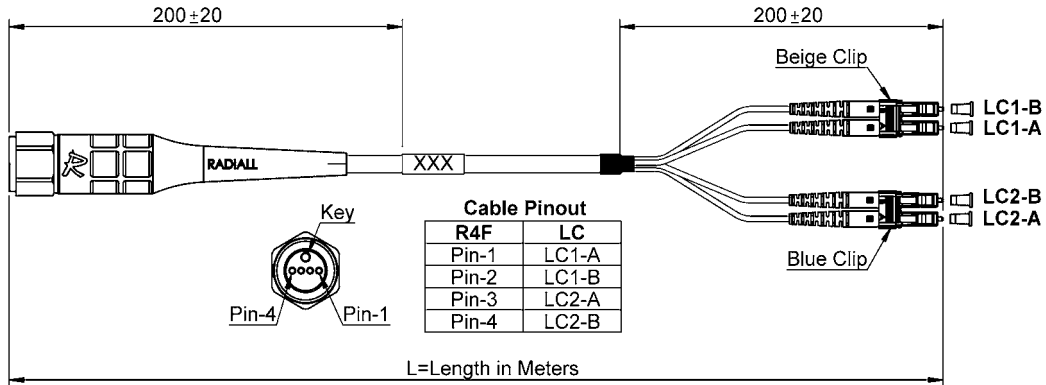

Fiber type	Part number (*)
SM 9/125 µm G652	F760 855 640-XX
MM 50/125 µm OM2	F760 858 640-XX

(*): Replace “XX” by the length in meters
 Standard length: 5 m and 50 m
 Ex: F760 855 640-05 for 5 m

R4F Plug to R4F Plug – Outdoor Field Cable Ø5 mm

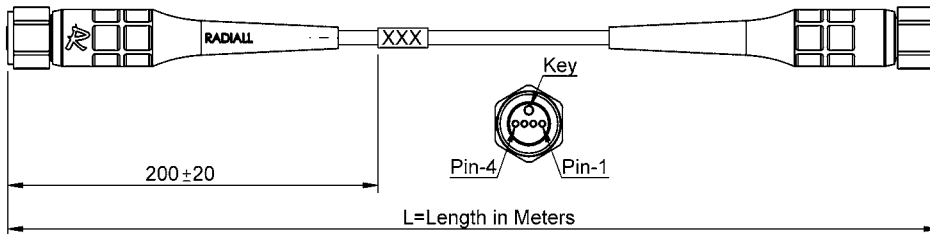

Fiber type	Part number (*)
SM 9/125 µm G652	F760 885 640-XX
MM 50/125 µm OM2	F760 888 640-XX

(*): Replace “XX” by the length in meters
 Standard length: 5 m and 50 m
 Ex: F760 885 640-05 for 5 m



Accessories and Tools

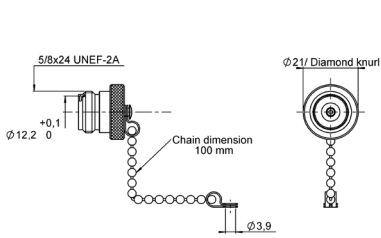

Fig. 1

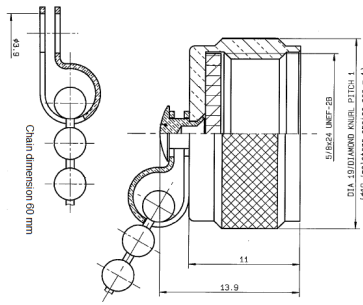

Fig. 2

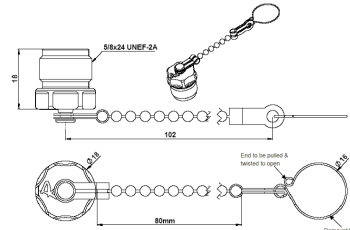

Fig. 3

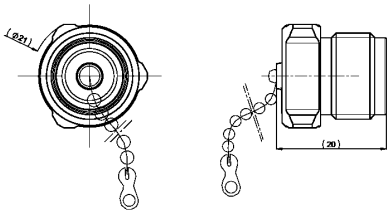

Fig. 4

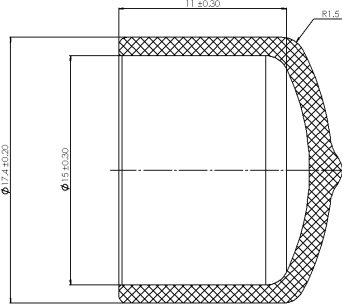

Fig. 5

Part number	Description	Fig.
R161 841 010	Metal female protective cap with chain	1
R161 853 000	Metal male protective cap with chain	2
RXF0 129 500	Plug plastic cap with chain and removable tether	3
243 25 810	Plug plastic cap with chain	4
240 92 675	Vinyl plastic cap	5

Accessories and Tools



The mechanical cleaning tool to clean RXF optical end-faces. The tool uses a dry cleaning strand to gently sweep and lift away dust and residue from the connector end-face.

Part number	Description	Packaging
F780 906 001	RXF cleaning tool	Unitary



OCTIS™ SERIES

Contents

OCTIS

Introduction..... 9-4

Characteristics 9-5

SFP / SFP+ 9-6

RJ45 9-7

Power 9-8

Signal 9-9

Combo 9-9

Universal 9-10

Accessories and tools 9-11

SECTION 9 TABLE OF CONTENTS

Introduction



OCTIS™ is a compact multi-standard solution designed for outdoor wireless applications where reliability and high data transmission are required. OCTIS™ provides a robust I/O solution that can operate in harsh environments.

APPLICATIONS

- Wireless communications
- Industry
- Energy

Features and Benefits

- *Suitable for harsh environments*
 - Waterproof connection
 - Dust proof
 - Corrosion resistant
 - Extreme temperatures withstanding
 - Cable tensile and side load
 - EMI shielding
 - Lightning resistant
- *Quick and easy installation*
 - Blind mating
 - Visual coding
 - Physical coding
 - Field assembly of the plugs on the cable
 - Turn-key design of the equipment front panel to integrate the receptacle
- *Versatile solution*

The complete OCTIS™ range offers a variety of interface solutions including:

 - SFP
 - RJ45 for tab up socket
 - RJ45 for tab down socket
 - Power DC with 2 contacts + cable shielding
 - Power AC with 3 contacts
 - Multipin signal from 8 to 12 pins, compatible with Ethernet Cat5e
 - Combo with Power DC and signal multipin in one single connection
 - Universal: for LC DUplex, SC, USB, etc.

Characteristics

Test / Characteristics	Values / Remarks				
	SFP	RJ45	Power	Signal	Combo

MECHANICAL CHARACTERISTICS

Coupling mechanism	Lever + locking button				
Durability (mating cycles) (IEC 61300-2-2)	100 min (50 before and 50 after thermal cycles)				
Tensile load on cable (IEC 61300-2-4)	150 - 200 N depending on cable				
Side load on cable (GR950)	50 N min				
Cable size	5 to 11 mm jacket diameter (with proper grommet size)				
Vibration (IEC 61300-2-1)	GR-950(12/2010), GR3108(12/2008)				
Low level vibration (IEC 61300-2-1)	GR-950(12/2010), GR3108(12/2008)				
Packaged equipment shock (GR-950)	Fall from 1 m				

ENVIRONMENTAL CHARACTERISTICS

Temperature range	-40 ... +85°C				
Thermal aging (GR950)	90°C during 720h then 24 hours at 23°C				
Thermal cycling (GR950)	120 cycles equivalent to 30 days				
Corrosion	720 h salt mist + SO ₂ (ISO21207)				
Ozone exposure (GR-950, ASTM D 518, ASTM D 1149)	Rubber components : 40°C during 70h; Ozone 50 mPa				
Ingress protection	IP67 - IP68 (when mated)				
RoHS	compliant				
Flammability	UL94-V0				
UV resistance (GR950, ASTM G154)	UVB 1000 hours				
Fungus resistance (GR-950, ASTM G 21)	Incubation 28 days, 29°C, 96%RH				

ELECTRICAL CHARACTERISTICS

Contact resistance	IEC 60512, Test 2a	≤4 mΩ @ 20A DC (EIA 364-06)	55 mΩ Max (EIA 364-23B, 4 wire method)	Same as Power and Signal	
Working voltage	Refer to Cable assembly characteristics	300 V AC (r.m.s)			
Insulation resistance (EIA 364-21)		5000 MΩ min			
Dielectric Withstanding Voltage (EIA 364-20)		500V AC during 60 s @ 1 atm	1000V AC during 60 s		
Current rating		16A with AWG16 wire (7xAWG24) 20A with AWG14 wire (7xAWG22)	1,5 A per pair		
Cross talk			Pair to pair @20MHz < -60dB All pairs to one victim @ 20MHz < -54dB (powersum)		
Impedance of pairs			100Ω +/- 10% @ 30 MHz		
IL		Refer to Cable assembly characteristics	< 0.1 dB @ 30MHz		
RL			< -37 dB @ 20MHz		
EMI shielding		Full EMI shielding of the panel cavity	EMI shielding by reduction of the panel cavity		
Grounding			Direct connection of cable braiding to the panel		
Lightning (IEC 62305-1)		> 5KA with wave form 10/350 μs on cable braiding > 1KA with wave form 10/350 μs on individual wires > 5KA with wave form 10/350 μs on all wires together > 2,2 KA with wave form 8/20 μs on individual wires			
Conducted immunity Surge (GR-1089-CORE – R4-25) (IEC 61000-4-5)"		> 6KV on individual wires > 6KV on all wires together Wave form 1,2/50 μs – open circuit /8/20 μs – short circuit 2 ohm			

RJ45

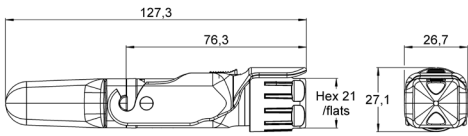

Fig. 1

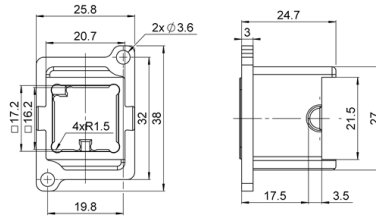

Fig. 2

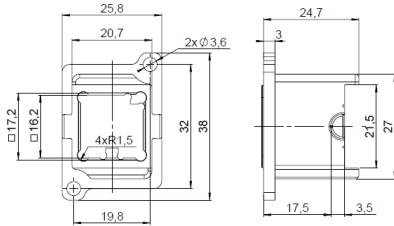

Fig. 3

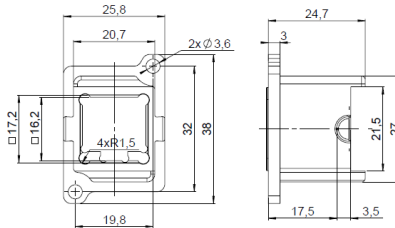







Fig. 4

Part number		Description	Fig.
OCTI 217 500		RJ45 Tab Up Plug kit, coding left*	1
OCTI 207 500		Receptacle kit RJ45 coding left	2
OCTI 217 505		RJ45 Tab Up Plug kit, coding right*	1
OCTI 207 505		Receptacle kit RJ45 coding right	3
OCTI 217 550		RJ45 Tab Down Plug kit*	1
OCTI 207 550		RJ45 Tab Down Receptacle	4

* To be used with specific board socket, contact us for more information.

Power

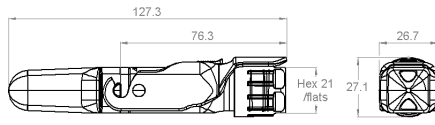

Fig. 1

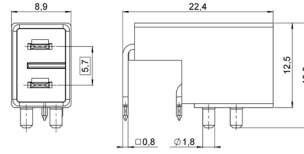

Fig. 2

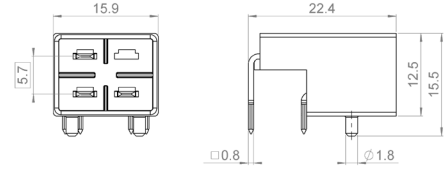

Fig. 3

Part number	Description	Contacts	Fig.
OCTI 317 500	Power Plug kit, crimp contacts	2 power contacts + cable grounding	1
OCTI 327 500	Power Plug kit for field assembly		
OCTI 360 500	Power board socket		2
OCTI 337 500	Power Plug kit, crimp contacts	3 power contacts	1
OCTI 337 550	Power Plug kit for field assembly		
OCTI 363 500	Power board socket		3

Signal

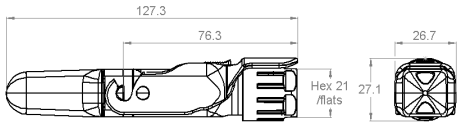

Fig. 1

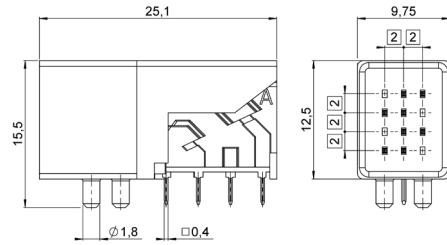

Fig. 2

Part number	Description	Contacts	Fig.
OCTI 417 500	Signal Plug kit	8 signal contacts + cable grounding	1
OCTI 407 500	Signal receptacle		3
OCTI 460 500	Signal board socket		2

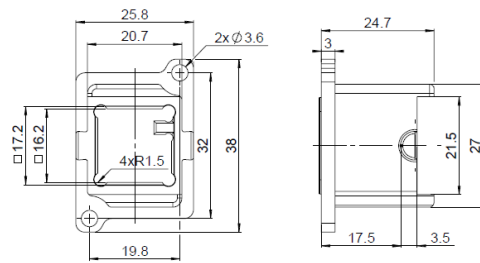

Fig. 3

Combo

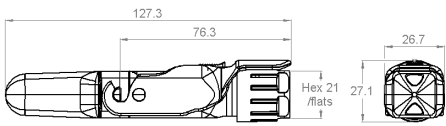

Fig. 1

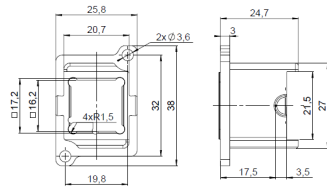

Fig. 2

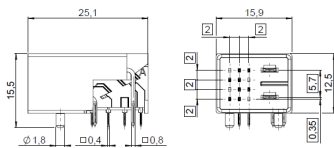

Fig. 3

Part number	Description	Contacts	Fig.
OCTI 517 500	Combo Plug kit	2 Power contacts + 8 signal contacts + cable grounding	1
OCTI 560 500	Combo board socket		3
OCTI 507 500	Combo receptacle		2

Universal

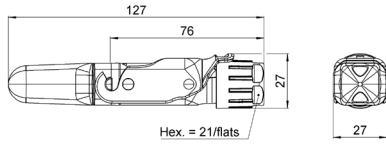

Fig. 1

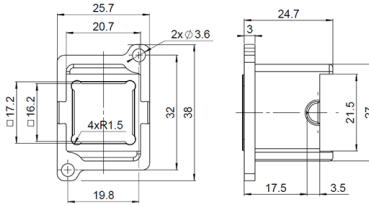



Fig. 2

Part number	Description	Fig.
OCTI 127 500	 <p>Plug kit for panel adaptor</p>	1
OCTI 907 500	 <p>Universal screw-on receptacle**</p>	2

** Suited for any cable assembly with interface fitting through a 15 mm diameter hole.

Accessories and Tools

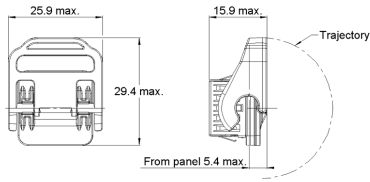

Fig. 1

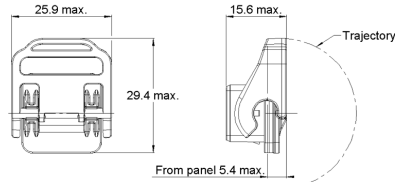

Fig. 2

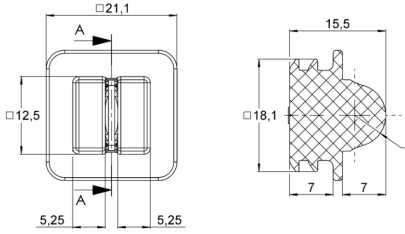

Fig. 3

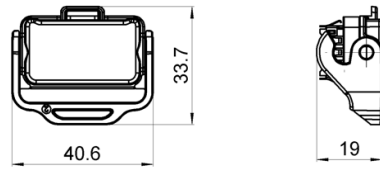



Fig. 4

Part number		Description	Fig.
OCTI 957 500		EMI + IP67 receptacle cap	1
OCTI 957 550		IP 67 receptacle cap	2
OCTI 955 500		Dust cap	3
OCTI W57 500		Universal cap	4



HEP2R PLATING

Contents



HEP²R

Introduction..... 10-4 to 10-5

SECTION 10 TABLE OF CONTENTS



Introduction



Initial State



After NSS 720Hrs



After ISO 21207 5 Cycles

Overview

Today, telecommunication operators are installing more equipment in high humidity, hot temperature conditions which ultimately subjects the products to corrosive gases from industrial or traffic environments.

To meet the needs of these harsh environments a new solution is required. This solution should enable products to withstand neutral salt spray for 720 hours and ISO 21207 – a test procedure simulating severe industrial or traffic environment.

In the past, BBR or white bronze plating was typically used but has proven to result in unsatisfactory corrosion resistance levels. To improve the performance of products, post-treatment was applied on BBR or silver+BBR plated products. Although this showed some improvement, post-treatment is not considered a long term, reliable solution and can provide additional risks over the product life cycle.

ISO 21207 METHOD B

Corresponding test duration vs Years in specified environment

Weeks	Life Cycle Years
1 Week	3 Years
2 Weeks	8 Years
3 Weeks	14 Years
5 Weeks	27 Years

Source: International Standard ISO 21207 (2004)

Introduction



HEP²R provides similar galvanic cells to bronze alloy surface treatment, which makes this plating solution ideal for commonly used materials and alloy in coaxial connectors.

Since 1977, Radiall has been dedicated to developing plating solutions for industrial applications. Over the years, Radiall has studied several plating alloys to meet the stringent requirements harsh environments produce.

HEP²R (Harsh Environment Protective Plating by Radiall) is a new plating solution that meets ASTM B 117 & ISO 21207 Method B 5 cycle testing.

Due to its unique benefits, HEP²R has received attention from the telecom industry and is the preferred plating solution to protect outdoor connectors in high corrosion environments for a long period. HEP²R is a cost effective plating solution suitable for outdoor connectors where maintaining the products appearance is critical.

To determine product performance and durability, products undergo ISO 21207 testing which simulates 27 years of exposure in severe traffic environment or industrial environment with salt spray contamination. Radiall's HEP²R has successfully passed ISO 21207 testing and showed no corrosion and very little change in appearance.

APPLICATIONS

Based on its environmental performance, HEP²R plating is mainly dedicated for Telecom applications with a focus on 4.3-10 and 7/16 connectors. For use on other products exposed to salt spray contamination or corrosive gases, please consult us.

FEATURES & BENEFITS

- Very low intermodulation [-135 dBm on 4.3-10 connector]
- No change on VSWR compared to similar product plated with BBR
- High corrosion resistance (ASTM B 117 / TELCORDIA GR-487-CORE / ISO 21207 Method B 5 Cycles)
- Similar galvanic cell level compared to BBR plating
- High hardness
- Anti-seize properties
- Not subject to whiskers
- Non magnetic plating
- Good solderability
- Hypoallergenic plating
- RoHs and REACH compliant
- Cyanides free

INDEX

Part Number Index



Radiall Part Numbers**N SERIES**

R161 050 300.....	4-8
R161 051 000.....	4-8
R161 052 000.....	4-8
R161 053 000.....	4-8
R161 054 000.....	4-8
R161 072 000.....	4-8
R161 075 030.....	4-8
R161 082 120.....	4-8
R161 082 200.....	4-8
R161 088 180.....	4-8
R161 182 080.....	4-9
R161 152 107.....	4-9
R161 183 310.....	4-9
R161 184 080.....	4-9
R161 188 200.....	4-9
R161 226 020.....	4-10
R161 227 000.....	4-10
R161 277 300.....	4-10
R161 278 000.....	4-10
R161 323 000.....	4-12
R161 329 130.....	4-12
R161 329 140.....	4-12
R161 331 400.....	4-12
R161 335 200.....	4-12
R161 336 000.....	4-12
R161 336 200.....	4-12
R161 337 200.....	4-12
R161 404 C01.....	4-15
R161 404 C02.....	4-15
R161 404 C03.....	4-15
R161 410 000.....	4-13
R161A 410 000.....	4-13
R161 410 130.....	4-13
R161 418 000.....	4-13
R161 461 000.....	4-13
R161 404 000.....	4-14
R161A 404 000.....	4-14
R161 404 137.....	4-14
R161 416 130.....	4-14
R161 419 020.....	4-14
R161 419 300.....	4-14
R161 438 200.....	4-14
R161 441 000.....	4-12
R161 441 400.....	4-14
R161 570 000.....	4-16
R161 606 000.....	4-16
R161 625 000.....	4-16
R161 653 000.....	4-15
R161 703 000.....	7-8
R161 705 000.....	7-8
R161 715 000.....	7-8
R161 730 000.....	7-8
R161 753 000.....	7-8
R161 771 000.....	7-8
R161 791 500.....	7-8
R161 791 530.....	7-8
R161 804 000.....	4-17
R161 805 410.....	4-17
R161 841 000.....	4-17
R161 844 000.....	4-17
R161 853 000.....	4-17
R161 862 000.....	4-17

4.1-9.5 SERIES

R170 031 007.....	3-6
R170 031 107.....	3-6
R170 031 207.....	3-6
R170 152 107.....	3-6
R170 413 127.....	3-6

NEX10 SERIES

R180 052 007.....	1-6
R180 052 017.....	1-6
R180 060 007.....	1-6
R180 060 017.....	1-6
R180 252 007.....	1-7
R180 300 007.....	1-6
R180 301 007.....	1-6
R180 415 007.....	1-7
R180 540 007.....	1-7
R180 805 007.....	1-7
R180 805 010.....	1-7

4.3-10 SERIES

R183 030 007.....	2-6
R183 030 017.....	2-6
R183 031 007.....	2-6
R183 031 017.....	2-6
R183 032 007.....	2-6
R183 052 007.....	2-6
R183 165 007.....	2-7
R183 197 007.....	2-7
R183 252 007.....	2-7
R183 405 067.....	2-7
R183 703 007.....	7-9
R183 705 007.....	7-9
R183 707 007.....	7-9
R183 804 020.....	2-8

7-16 SERIES

R185 054 020.....	5-8
R185 077 010.....	5-8
R185 083 310.....	5-8
R185 085 007.....	5-8
R185 215 200.....	5-8
R185 216 200.....	5-8
R185 217 200.....	5-8
R185 252 000.....	5-9
R185 314 100.....	5-9
R185 320 020.....	5-9
R185 403 490.....	5-10
R185 403 547.....	5-10
R185 404 200.....	5-10
R185 405 200.....	5-10
R185 406 090.....	5-10
R185 703 000.....	7-7
R185 705 000.....	7-7
R185 707 000.....	7-7
R185 710 000.....	7-7
R185 730 020.....	7-7

RECEPTACLES

R187 403 010.....	5-11
R187 130 000.....	5-11

R187 403 000.....	5-11
R187 403 100.....	5-11
R187 406 000.....	5-11
R187 406 100.....	5-11
R187 413 000.....	5-11
R187 413 100.....	5-11
R187 416 000.....	5-11
R187 416 100.....	5-11

ADAPTER SERIES

R191 591 007.....	7-4
R191 591 017.....	7-5
R191 592 007.....	7-5
R191 592 017.....	7-4
R191 592 027.....	7-5
R191 592 037.....	7-4
R191 598 007.....	7-4
R191 620 007.....	7-5
R191 620 017.....	7-5
R191 620 027.....	7-5
R191 620 037.....	7-4
R191 621 007.....	7-6
R191 621 017.....	7-6
R191 630 007.....	7-5
R191 720 000.....	7-5
R191 721 000.....	7-5
R191 722 000.....	7-5
R191 723 000.....	7-5

RxF ACCESSORIES

243 25 810.....	8-11
240 92 675.....	8-11

TOOLS

R282 202 000.....	4-17
R282 303 050.....	1-7
R282 303 240.....	2-9
R282 303 500.....	4-17

Radiall Part Numbers**JUMPER SERIES**

R296 702 807 xxx.....	6-5
R296 702 808 xxx.....	6-5
R296 702 809 xxx.....	6-5
R296 702 810 xxx.....	6-5
R296 702 811 xxx.....	6-5
R296 702 812 xxx.....	6-5
R296 702 813 xxx.....	6-5
R296 702 814 xxx.....	6-5
R296 702 815 xxx.....	6-5
R296 702 816 xxx.....	6-5
R296 702 817 xxx.....	6-5
R296 702 818 xxx.....	6-5

4.3-10 SERIES

R404 1D1 121	2-9
R404 758 000.....	2-10
R404 759 000.....	2-10
R404 1D2 000	2-9
R404 1D2 121	2-9
R404 1D5 000	2-9

TERMINATIONS & ATTENUATORS

R404 131 000.....	4-19
R404 131 120.....	4-19
R404 132 000.....	4-19
R404 170 111.....	5-13
R404 507 000.....	4-19
R404 557 000.....	4-19
R404 750 000.....	4-19
R404 751 000.....	4-19
R404 758 000.....	2-10
R404 759 000.....	2-10
R404 756 000.....	5-13
R412 700 000.....	4-20
R412 700 124.....	4-20
R412 806 000.....	5-14
R415 6XX 000.....	2-10
R415 703 000.....	4-21
R417 303 110.....	4-21

R417 303 130.....	4-21
R420 303 110.....	5-14
R494 175 111.....	5-13
R494 564 000.....	5-13

CABLE

F760 855 220	8-8
F760 855 240	8-8
F760 855 620-XX	8-9
F760 855 640-XX	8-10
F760 858 220	8-8
F760 858 240	8-8
F760 858 620-XX	8-9
F760 858 640-XX	8-10
F760 885 620-XX	8-9
F760 885 640-XX	8-10
F760 888 620-XX	8-9
F760 888 640-XX	8-10

TOOLS (RxF)

F780 906 001	8-12
F760 888 640-XX	8-10

RxF

RXF0 129 500.....	8-11
RXF2 130 500.....	8-6
RXF2 130 600.....	8-6
RXF2 130 700.....	8-6
RXF2 131 500.....	8-6
RXF2 131 510.....	8-6
RXF2 131 600.....	8-6
RXF2 131 700.....	8-6
RXF4 130 500.....	8-6
RXF4 130 700.....	8-6
RXF4 131 500.....	8-6
RXF2 330 500.....	8-7
RXF2 331 500.....	8-7
RXF2 430 200.....	8-7
RXF2 431 200.....	8-7
RXF4 230 200.....	8-7
RXF4 231 200.....	8-7

RXF4 330 500.....	8-7
RXF4 330 500.....	8-7
RXF4 331 500.....	8-7
RXF4 430 200.....	8-7
RXF4 431 200.....	8-7

OCTIS™ SERIES SFP

OCTI 107 500	9-6
OCTI 117 500	9-6
OCTI 140 500	9-6
OCTI 140 505	9-6
OCTI 140 550	9-6

RJ45

OCTI 207 500	9-7
OCTI 207 505	9-7
OCTI 207 550	9-7
OCTI 217 500	9-7
OCTI 217 505	9-7
OCTI 217 550	9-7

POWER

OCTI 317 500	9-8
OCTI 327 500	9-8
OCTI 337 500	9-8
OCTI 337 550	9-8
OCTI 360 500	9-8
OCTI 363 500	9-8

SIGNAL

OCTI 407 500	9-9
OCTI 417 500	9-9
OCTI 460 500	9-9

COMBO

OCTI 507 500	9-9
OCTI 517 500	9-9
OCTI 560 500	9-9

UNIVERSAL

OCTI 127 500	9-10
OCTI 907 500	9-10

ACCESSORIES

OCTI 955 500	9-11
OCTI 957 500	9-11
OCTI 957 550	9-11
OCTI W57 500	9-11

N SERIES (CABLE GROUP)

4502-7041-010	4-12
4202-7041-009	4-12
4501-9543-009	4-12

SIMPLIFICATION is our INNOVATION

We advance the design and engineering process for innovators, ground-breakers and pioneers of technology. We reduce weight, improve durability and streamline installation to provide leading-edge connectors that drive product performance.

AREA OFFICES LOCAL CONTACTS

EUROPE

ADDRESS	PHONE	FAX	EMAIL
FINLAND Radiall Finland PO Box 202, 90101, Oulu	+358407522412		infofi@radiall.com
FRANCE Radiall SA 25 Rue Madeleine Vionnet, 93300, Aubervilliers	+33149353535		info@radiall.com
GERMANY Radiall GmbH Carl-Zeiss-Straße 10, 63322, Rödermark	+49607491070	+496074910710	infode@radiall.com
ITALY Radiall Elettronica S.R.L. Via Zambelletti 19, 20021, Baranzate Milano	+39024885121	+390248843018	infoit@radiall.com
NETHERLANDS Radiall Nederland BV Hogebrinkerweg 15b, 3871, KM Hoevelaken	+31332534009	+31332534512	infonl@radiall.com
SWEDEN Radiall AB Sollentunavägen 63, 191 40 Sollentuna	+4684443410		infose@radiall.com
UNITED KINGDOM Radiall Ltd. Profile West, 950 Great West Rd., Brentford, Middlesex TW8 9ES	+441895425000	+441895425010	infouk@radiall.com

ASIA

CHINA Shanghai Radiall Electronics Co., Ltd. No.390, Yonghe Road, Shanghai, 200072	+862166523788	+862166521177	infozh@radiall.com
HONG KONG Radiall Electronics (Asia) Ltd. Room A, 16/F., Ford Glory Plaza, 37-39 Wing Hong Street, Cheung Sha Wan, Kowloon, Hong Kong	+85229593833	+85229592636	infohk@radiall.com
INDIA Radiall India Pvt. Ltd. 25D, Phase 2, Peenya Industrial Area, Bengaluru 560 058	+98028395271	+918028397228	infoin@radiall.com
JAPAN Nihon Radiall K.K. Sawada Building 8F, Shibuya-ku, Tokyo 150-0011	+0364274455	+0364274456	infojp@radiall.com

AMERICAS

USA & CANADA Radiall USA, Inc. 8950 South 52nd Street, Ste. 401 Tempe, AZ 85284	+14806829400	+14806829403	infousa@radiall.com
--	--------------	--------------	---------------------

GLOBAL PRESENCE

*Australia · Austria · Belgium · Brazil · Czech Republic · Denmark · Estonia · Greece · Hungary · Indonesia · Israel · Korea · Latvia · Lithuania
Malaysia · Norway · Philippines · Poland · Portugal · Russia · Singapore · Spain · Switzerland · Taiwan · Thailand · Vietnam · South Africa*