



**Nexans Automotive
Expertise by Experience and R&D**

Automotive Cables from Nexans Nuremberg

Nexans automotive cables have been used in a wide range of applications for many years. New applications and the rate of innovation in vehicles lead to

increasingly high demands for adapted cables. Nexans Nuremberg is specialised in high-performance automotive cables, particularly in the high-temperature range.

Content

Application areas:	Overview	3
	Safety and Chassis	11
	Engine and Transmission	19
	Comfort and Car Body	31
	Control and Car Multimedia	37
Production	Plant Nuremberg – your competent partner	4
Cable Types	Overview	5
Technology	Abbreviations	6
	Conductor Specification	7
	Insulation Materials	8
General Information	Pictographs	10
	About Nexans	42
	Quality and Certificates	44
	Packaging	45
	Quotation Request Form	47

The specified data has been determined precisely; however, it is only given as an indication and does not relieve you of the responsibility for checking that the products supplied by us are suitable for the intended purpose.

Processing and use of the products are outside our control and therefore are your sole responsibility.

Expertise achieved through experience and R&D

Optimum conditions for new development projects are guaranteed by the group's on-site development centre for materials and process technology. The Nuremberg plant focuses

particularly on special cables in the areas of safety and drive units, engines and transmissions, comfort and car body, and control and multimedia. Nexans offers the suitable solution for all major fields of application.



Safety and Chassis

Sensor cables for ABS, airbags and other safety applications

from page 11 on



Engine and Transmission

Wiring cables for the engine compartment, gear box connection cables, sensor cables for oxygen sensors and other applications

from page 19 on



Comfort and Car Body

Cables for car body harnesses, seat heating cables, cables for electrical window opening and seat adjustment and other applications.

from page 31 on



Control and Car Multimedia

BUS cables and coaxial cables for communication and other applications

from page 37 on



The following pages contain examples of our product range. Other cables are available on request. Special designs according to customer requirements are one of Nexans Nuremberg's strong points.

Nexans Nuremberg – Your specialised partner

Partner of the automotive industry

With a history of over 100 years, the Nuremberg plant has established its reputation as a reliable supplier of automotive cables.

Automotive production area

The production of common automotive cables is organised in a separate production area. This enables efficient production with a machine base adapted to the products ranging from single cores to complex hybrid designs.



High-temperature production area

As a specialist in high-temperature cables (up to 260°C/3000 hrs), Nexans Nuremberg is equipped with modern production installations for all relevant high-temperature materials including PTFE.

Irradiation cross-linking

With our own irradiation cross-linking equipment and extensive experience with the materials and processes involved, cross-linked insulation materials are frequently used in our products.

PVC and special mixture production

We develop and manufacture a significant proportion of the insulating materials used. The plant is equipped with extensive capacities for PVC compounds and for flame retardant halogen-free material and special compounds, e.g. for cross-linked cables.

Competence in material development for automotive cables

Plant Nuremberg is home of the Nexans Research Center for material development and processing technology, which is working for the entire Nexans group worldwide.

The outcome of this is a large expertise in the development of standardized cables and above all also customer specific solutions for outstanding application areas:



- Development of new materials and processes.
- Electrical, mechanical, thermal and rheological tests
- Flame tests on materials and cables
- Trial plant: production of compounds and complete cables on 4 extrusion lines, e.g. sample production
- Recycling and standardization activities
- High mechanical load, alternating bending stress, torsion
- Extreme temperatures, -60 to +260°C (PVC, HFFR, PTFE)
- Heavy environmental conditions (oils, fuels, acid, lye, UV-radiation)
- Special characteristics in case of fire (flame retardant, low smoke, halogen free, low toxicity, sustainment of functionality in case of fire)

Overview Cable Types

Single Core Cables

Product	Application	page
FLY	Comfort and Car Body	32
FLRY-A	Comfort and Car Body, Engine and Transmission	20
FLRY-B	Comfort and Car Body, Engine and Transmission	21
FLYY	Comfort and Car Body	33
FLR5Y	Engine and Transmission	28
FLR6Y	Engine and Transmission	26
FLR7Y	Engine and Transmission	25
FLR13Y	Engine and Transmission	23
FLR14Y	Engine and Transmission	27
FLRX	Engine and Transmission	22
FLR2X	Engine and Transmission	24

Multicore Cables

Product	Application	page
FLYY	Comfort and Car Body	34
FLRYY	Comfort and Car Body, Safety and Chassis	12
FLY11Y	Safety and Chassis	13
FLRY11Y	Safety and Chassis	15
FLR7Y12X	Engine and Transmission	30
FLR7YB12X	Engine and Transmission	30
FL4G11Y	Safety and Chassis	16
FLR4G11Y	Safety and Chassis	16
FLR2X11Y	Safety and Chassis	17
FLR2XHX	Safety and Chassis, Engine and Transmission	29
FLR10Y2X	Safety and Chassis	18

Bus and Coaxial Cables

Product	Application	page
FLO2YSBY CAN3	Control and Car Multimedia	38
Coaxial cables	Control and Car Multimedia	40
Elcurigid	Control and Car Multimedia	39

Safety and Chassis
from page 11 on



Comfort and Car Body
from page 31 on



Engine and Transmission
from page 19 on



Control and Car Multimedia
from page 37 on



Abbreviations for Automotive Cables

The model reference indicates the design and materials used in a cable in abbreviated form. The sequence of abbreviations from left to right corresponds to the cable design.

1. Type of Cable

FL	car (automotive) cable
FLZ	car (automotive) ignition cable

2. Conductor Materials

no abbreviation	electrolytic copper
M	other materials than E-Cu or electrical resistance alloys
W	resistance wires

3. Characteristics of insulation materials

no abbreviation	normal thickness
R	reduced insulation thickness
U	ultra thin insulation
S	reinforced (increased) insulation

4. Insulation and Sheath Materials

abbreviations for insulation and jacket materials according to table below

5. Shielding and special sheaths

B	screen (film, foil) shield
C	copper wire braiding
D	copper wire spinning

6. Special Designs

F	flat cable
Z	multicore separable cable

7. Number of Cores and Cross Section

indication of number of cores and cross section (mm²)

Example:

FLYBY 2x0,75	
FL	automotive cable
Y	PVC-insulation
B	foil (screen) shielding
Y	outer sheath of PVC
2x0,75	2 cores, nominal cross section 0,75 mm ²

Conductor Specifications

Bare Copper

copper wire	Cu-ETP1 according to DIN EN 13602
melting point	copper: 1083 °C
conductivity at 20 °C	58,5 m/(Ωmm ²)
density	8,925 kg/dm ³
advantages	<ul style="list-style-type: none"> • low priced

Tin Plated Copper

copper wire	Cu-ETP1 according to DIN EN 13602
Tin	Sn 99,90 DIN 1704
melting point	copper: 1083 °C, Tin: 232 °C
conductivity at 20 °C	57,5 m/(Ωmm ²)
density	8,925 kg/dm ³
advantages	<ul style="list-style-type: none"> • good soldering ability • protection of insulation mix • good protection against corrosion

Nickel Plated Copper

copper wire	Cu-ETP1 according to DIN EN 13602
Nickel	Ni 99,9 DIN 1702
melting point	copper: 1083 °C, Nickel: 1455 °C
conductivity at 20 °C	57,0 m/(Ωmm ²)
density	8,925 kg/dm ³
advantages	<ul style="list-style-type: none"> • high temperature resistant • high corrosion resistant

Silver Plated Copper

copper wire	Cu-OF1 according to DIN EN 13602
Silver	Ag (pure silver)
melting point	copper: 1083 °C, Silver: 960 °C
conductivity at 20 °C	59,0 m/(Ωmm ²)
density	8,925 kg/dm ³
advantages	<ul style="list-style-type: none"> • high temperature resistant • improved (better) surface conductivity (skin effect)

In addition to these conductors, various special conductors and alloys are used, which have a higher tensile strength or a better temperature resistance, for example. Further information on request.

Ab- breviation	Insulation Material chemical description	Short symbol acc. to DIN 76722	Classification acc. to ISO 6722	Thermal Properties		
				Continuous duty temperature (3.000 h) °C	Thermal overload capacity °C/48 h	Cold bending resistance °C
PVC	Polyvinyl Chloride	Y (YW)	A/B	90 / 105	140	-40
XPVC	Irradiation cross-linked PVC-compounds	X	A/B	90 / 105	140	-40
PE	Polyethylene	2Y	B	100	100	-50
TPE-E	Thermoplastic Polyester-Elastomer Hytrel®	13Y	C	110	150	-40
TPE-U (PUR)	Thermoplastic Polyurethane-Elastomer Elastollan® Eslane®	11Y	C	125	150	-50
XPE	Irradiation cross-linked PE-compounds	2X	C/D	125	200	-40
EVA	Ethylene-Vinylacetat- Copolymer-compounds	4G	C	130	160	-40
HX	Irradiation cross-linked Copolymer-compounds	-	D	150	200	-40
XTPE-E	Irradiation cross-linked Polyester-Elastomer-compounds	12X	D	150	200	-40
PVDF	Polyvinylidenfluorid Dyflor® Kynar®	10Y	D	155	160	-65
ETFE	Ethylen-Tetrafluor- ethylen-Copolymer Hostaflon®-ET Tefzel®	7Y	E	180	230	-65
FEP	Perfluorethylen- propylen-Copolymer Hostaflon®-FEP Teflon®-FEP	6Y	F	210	240	-65
PFA	Perfluoralkoxy- Tetrafluorethylencopolymer Hostaflon®-PFA Teflon®-PFA	14Y	H	260	270	-65
PTFE	Polytetrafluorethylen Hostaflon®-TF Teflon®-PTFE	5Y	H	260	310	-65

Other materials are available on request.

We would be happy to send you our material catalogue with detailed information.

Insulation and Sheath Materials and their properties

Specific resistance at 20 °C	Shore hardness A/D	Tensile strength	Elongation at break	Abrasion	Flame retardant	Resistant against:				
						Oil	Fuel	Breaking fluid	Acid/Lye	Organic media
$\Omega \times \text{cm}$		M Pa	%							
$> 10^{12}$	A85-95	> 10	> 150	+	+	+	+	-	+	-
$> 10^{12}$	A85-95	> 10	> 150	++	+	+	+	+	+	+
$> 10^{16}$	D45-55	> 15	> 300	+	-	-	+	-	++	-
$> 10^{10}$	D40-78	> 25	> 300	++	-	++	++	+	-	+
$> 10^9$	A75-D54	> 30	> 300	++	-	++	++	+	+	+
$> 10^{13}$	A95-D50	> 10	> 100	+	+	+	+	+	+	+
$> 10^{13}$	A80-90	> 10	> 200	+	-	+	+	+	+	+
$> 10^{11}$	A92	> 10	> 100	+	+	+	+	+	+	+
$> 10^{11}$	A88	> 15	> 200	+/-	+	++	++	++	++	++
$> 10^{14}$	D75-80	> 20	> 100	++	+(+)	++	++	++	++	+
$> 10^{16}$	D75-80	> 30	> 150	++	+(+)	++	++	++	++	++
$> 10^{16}$	D55-60	> 15	> 200	++	++	++	++	++	++	++
$> 10^{17}$	D55-65	> 20	> 200	++	++	++	++	++	++	++
$> 10^{17}$	D55-65	> 20	> 200	++	++	++	++	++	++	++

Pictographs

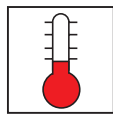

minimum authorised temperature during transfer and operation
maximum authorised temperature during continuous load (3000 h)

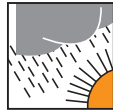

weather resistant



mechanical resistant

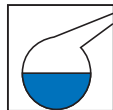

chemical resistant



flame retardant



low smoke



low corrosivity



low toxicity



flexible



halogene free



oil and fuel resistant



abrasion resistant

Safety and Chassis – Enjoyable driving with minimal risk



The increase in active and passive safety systems in recent years has also led to an increased demand for cables specially adapted to these systems.

Nexans took up the challenge at an early stage and produces, among other things, sensor cables

for airbags and various ABS sensor cables in different materials for light and heavy-duty vehicles. The area of braking systems involves strict requirements due to the high temperatures and various environmental influences, such as oil, salt water, or vibrations.

Products Safety and Chassis

Product	Cores	Cross section	Temperature (3000 h)	Application	Page
FLRYY	2	0,5 mm ²	- 40 to + 105 °C	Safety and Chassis Comfort and Car body	12
FLY11Y	2 - 7	0,5 - 4,0 mm ²	- 40 to + 105 °C	Safety and Chassis	13
FLRY11Y	3 - 6	0,5 - 4,0 mm ²	- 40 to + 105 °C	Safety and Chassis	15
FL4G11Y	2 - 4	0,5 - 0,75 mm ²	- 40 to + 125 °C	Safety and Chassis	16
FLR4G11Y	2	0,5 mm ²	- 40 to + 125 °C	Safety and Chassis	16
FLR2X11Y	2 - 3	0,5 - 0,6 mm ²	- 40 to + 125 °C	Safety and Chassis	17
FLR2XHX	2 - 10	0,75 mm ²	- 40 to + 125 °C	Safety and Chassis Engine and Transmission	29
FLR10Y2X	2 - 4	0,5 - 1,0 mm ²	- 40 to + 150 °C	Safety and Chassis	18

new development: temperature resistant sensor cable for + 150 °C

- very good thermal resistance from -40 °C to +150 °C/3000 h
- very good resistance against chemical agents
- very good processability in all harnessing steps
- very good cable extrusion with the established materials

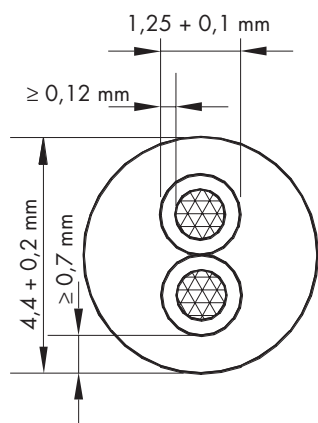

FLR10Y2X 2x0,5 mm²

Product	FLR10Y2X
Types	2 x 0,5; 2 x 0,75; 2 x 1,0; 4 x 0,5 mm ²
Core insulation	PVDF (Shore D 78 ± 5)
Sheath compound	2X (Shore A 90 ± 5)
Temperature range	-40 °C bis +150 °C (3000 h)

Detailed information on page 18.

Application

Cable for Airbag wiring.

Structure

1. Conductor

Cu-ETP1 bare
acc. to DIN EN 13602

2. Insulation

PVC lead free
Shore A 93 ± 5 DIN 53 505
DIN ISO 6722 class B

3. Shielding

–

4. Sheath

PVC lead free
Shore A 86 ± 5 DIN 53 505
Sheath colour: various



Standards

Various customer standards

Marking

Manufacturer own marking

Types

Designation	No. of cores x conductor cross section Nominal value No. x mm ²	Structure No. x max. Ø mm	Conductor		Cores		Sheath		Weight Guiding value kg/km
			Diameter Guiding value mm	max. conductor resistance (20 °C) Ω/km	Wall thickness min. mm	Diameter Guiding value mm	Wall thickness Guiding value mm	Outer Diameter Nominal value mm	
FLRYY 2x0,5	2 x 0,5	19 x 0,18	0,9	37,1	0,3	1,55	0,41	4,4 ± 0,2	30
FLRYY 5x0,5	5 x 0,5	19 x 0,18	0,9	37,1	0,3	1,55	0,65	6,0 ± 0,2	59

Other constructions upon request.

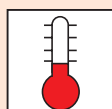

-40 - +105 °C

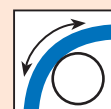
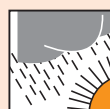

Application

Connection cable in cars and trucks, e.g. sensor cable for ABS systems.

Structure

1. Conductor

Cu-ETP1 bare
acc. to DIN EN 13602
structure acc. to VDE 295

2. Insulation

PVC lead free
Shore A 93 ± 5 DIN 53 505
DIN ISO 6722 class B

3. Shielding

–

4. Sheath

PUR
Shore A 86 ± 5 DIN 53 505
Sheath colour: black



Standards

Various customer standards

Marking

Manufacturer own marking

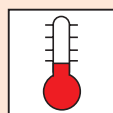

-40 - +105°C

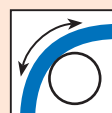
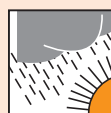

Types

Designation	No. of cores x conductor cross section Nominal value No. x mm ²	Structure No. x max. Ø mm	Conductor		Cores		Sheath		Weight Guiding value kg/km
			Diameter Guiding value mm	max. conductor resistance (20 °C) Ω/km	Wall thickness min. mm	Diameter Guiding value mm	Wall thickness Guiding value mm	Outer diameter Nominal value mm	
FLY11Y 2x0,75	2 x 0,75	24x0,21	1,1	26	0,5	2,25	0,58	6,0 ± 0,25	50
FLY11Y 2x1,5	2 x 1,5	28x0,26	1,5	13,3	0,5	2,55	0,58	6,8 ± 0,25	64
FLY11Y 3x0,5	3 x 0,5	16x0,21	0,9	39	0,5	2,05	0,58	5,9 ± 0,25	47
FLY11Y 3x1,5	3 x 1,5	28x0,26	1,5	13,3	0,5	2,55	0,58	7,0 ± 0,25	80
FLY11Y 4x0,5	4 x 0,5	16x0,21	0,9	39	0,5	2,05	0,58	6,3 ± 0,25	55
FLY11Y 4x1,0	4 x 1,0	32x0,21	1,3	19,5	0,5	2,45	0,58	7,3 ± 0,25	85
FLY11Y 5x0,5	5 x 0,5	16x0,21	0,9	39	0,5	2,05	0,58	7,0 ± 0,25	65
FLY11Y 2x1,0 + 3x0,5	2 x 1,0 + 3 x 0,5	32x0,21 16x0,21	1,3 0,9	19,5 39	0,5 0,5	2,45 2,05	0,58	7,85 ± 0,25	80
FLY11Y 2x2,5 + 1x1,5	2 x 2,5 + 1 x 1,5	46x0,26 28x0,26	2,05 1,5	7,98 13,3	0,5 0,5	3,0 2,55	0,58	8,4 ± 0,25	120
FLY11Y 2x2,5 + 2x0,5	2 x 2,5 + 2 x 0,5	46x0,26 16x0,21	2,05 0,9	7,98 39	0,5 0,5	3,0 2,05	0,58	8,1 ± 0,25	88
FLY11Y 2x2,5 + 3x0,5	2 x 2,5 + 3 x 0,5	46x0,26 16x0,21	2,05 0,9	7,98 39	0,5 0,5	3,0 2,05	0,58	8,3 ± 0,25	109
FLY11Y 2x4,0 + 3x1,5	2 x 4,0 + 3 x 1,5	56x0,31 28x0,26	2,5 1,5	4,95 13,3	0,5 0,5	3,45 2,55	0,58	10,6 ± 0,25	190
FLY11Y 3x1,5 + 4x0,5	3 x 1,5 + 4 x 0,5	28x0,26 16x0,21	1,5 0,9	13,3 39	0,5 0,5	2,55 2,05	0,58	8,9 ± 0,25	117
FLY11Y 3x2,5 + 1x1,5	3 x 2,5 + 1 x 1,5	46x0,26 28x0,26	2,05 1,5	7,98 13,39	0,5 0,5	3,0 2,55	0,58	9,6 ± 0,25	135
FLY11Y 5x1,0 + 3x0,5	5 x 1,0 + 3 x 0,5	32x0,21 16x0,21	1,3 0,9	19,5 39	0,5 0,5	2,45 2,05	0,58	8,8 ± 0,25	117
FLY11Y 3x0,5 + 1x2x0,5	3 x 0,5 + 1 x 2 x 0,5	16x0,21 16x0,21	0,9 0,9	39 39	0,5 0,5	2,05	0,58	7,5 ± 0,25	65
FLY11Y 2x4,0 + 3x1,5 + 1x2x1,5	2 x 4,0 + 4 x 0,5 + 1 x 2 x 1,5	56x0,31 16x0,21 28x0,26	2,5 1,5 1,5	4,95 13,3 13,3	0,5 0,4 0,5	3,45 2,3 2,55	1,0	13,2 ± 0,3	340

Other constructions upon request.

Application

Connection cable in cars and trucks with reduced wall thickness, e.g. for ABS systems.

Structure

1. Conductor

Cu-ETP1 bare
acc. to DIN EN 13602
structure acc. to DIN 72551
part 6 type A

2. Insulation

PVC lead free
Shore A 93 ± 5 DIN 53 505
ISO 6722 class B

3. Shielding

–

4. Sheath

PUR
Shore A 86 ± 5 DIN 53 505
Sheath colour: black



Standards

Various customer standards

Marking

Sheath marking

Types

Designation	No. of cores x conductor cross section Nominal value No. x mm ²	Structure No. of x max. Ø mm	Conductor Diameter Guiding value mm	max. conductor resistance (20 °C) Ω/km	Cores		Sheath		Weight Guiding value kg/km
					Wall thickness min. mm	Diameter Guiding value mm	Wall thickness Guiding value mm	Outer Diameter value mm	
FLRY11Y 3x0,75	3 x 0,75	19x0,23	1,2	24,7	0,24	1,8	0,58	5,6 ± 0,2	45
FLRY11Y 4x0,5	4 x 0,5	19x0,19	1,0	37,1	0,22	1,5	0,58	5,4 ± 0,2	40
FLRY11Y 5x1,5 + 1x0,5	5 x 1,5 + 1 x 0,5	19x0,32 19x0,19	1,7 1,0	12,7 37,1	0,24 0,22	2,3 1,5	0,7	8,1 ± 0,2	160
FLRY11Y 4x1,5	4 x 1,5	19x0,32	1,7	12,7	0,24	2,3	0,7	7,6 ± 0,2	96
FLRY11Y 2x4 + 1x2,5 + 3x1,5	2 x 4,0 1 x 2,5 + 3 x 1,5	56x0,30 19x0,40 19x0,32	2,60 2,05 1,60	4,7 7,6 12,7	0,32 0,28 0,24	3,50 2,85 2,30	0,75	10,2 ± 0,2	205

Other constructions upon request.

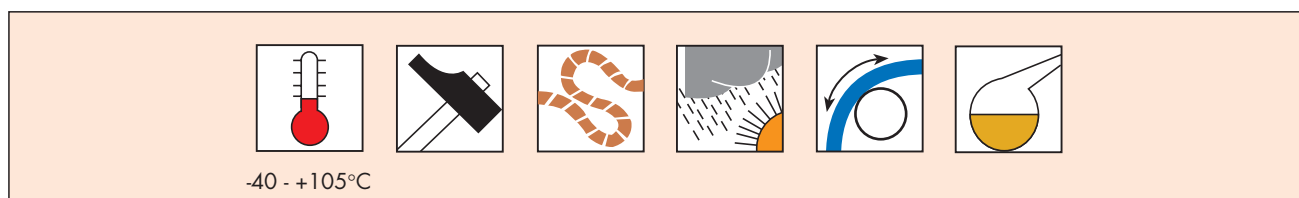

Application

Sensor cable for ABS systems with reduced or normal wall thickness.

Structure

1. Conductor

Cu-ETP1 finned
acc. to DIN EN 13602

2. Insulation

EVA
Shore A 83 ± 5 DIN 53 505

3. Shielding

–

4. Sheath

PUR
Shore A 86 ± 5 DIN 53 505
Sheath colour: black



Standards

Various customer standards

Marking

Sheath marking

Types

Designation	No. of cores x conductor cross section Nominal value No. x mm ²	Structure No. x max. Ø mm	Conductor		Cores		Sheath		Weight Guiding value kg/km
			Diameter Guiding value mm	max. conductor resistance (20 °C) Ω/km	Wall thickness min. mm	Diameter Guiding value mm	Wall thickness Guiding value mm	Outer Diameter Nominal value mm	
FL4G11Y 2x0,5	2x0,5	28x0,15	0,9	38,2	0,4	1,7	0,8	5,0 ± 0,2	35
FLR4G11Y 2x0,5	2x0,5	28x0,16	0,9	38,2	0,3	1,5	0,8	4,6 ± 0,2	32
FL4G11Y 2x0,75	2x0,75	40x0,16	1,1	27,1	0,5	2,2	0,9	6,2 ± 0,25	49
FL4G11Y 4x0,75	4x0,75	40x0,16	1,1	27,1	0,5	2,2	0,9	7,1 ± 0,25	70

Other constructions upon request.

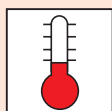

-40 - +125°C

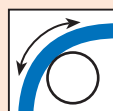
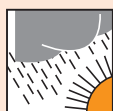

Application

Sensor cable with cross linked core insulation, e.g. for ABS systems.

Also available with good tensile and bending strength properties.

Structure

1. Conductor

Cu-ETP1 bare
acc. to DIN EN 13602
or special conductor

3. Shielding

–

2. Insulation

Irradiation cross linked PE
Shore D 58 ± 5

4. Sheath

PUR
Shore A 86 ± 5 DIN 53 505
Sheath colour: black



Standards

Various customer standards

Marking

Sheath marking

Special types

Special conductor
highly tensile and bending
resistant Cu-alloy, Cadmium-free

Types

Designation	No. of cores x conductor cross section Nominal value No. x mm ²	Structure No. x max. Ø mm	Conductor		Cores		Sheath		Weight Guiding value kg/km
			Diameter Guiding value mm	max. conductor resistance (20 °C) Ω/km	Wall thickness min. mm	Diameter Guiding value mm	Wall thickness Guiding value mm	Outer Diameter Nominal value mm	
FLR2X11Y 2x0,5	2x0,5	19x0,19	1,0	37,1	0,3	1,5	0,75	5,0 ± 0,2	32
FLR2X11Y 2x0,6	2x0,6	19x0,21*	1,1	46	0,25	1,5	0,5	4,4 ± 0,2	31
FLR2X11Y 3x0,6	3x0,6	19x0,21*	1,1	46	0,25	1,5	0,5	5,0 ± 0,25	38

Other constructions upon request.

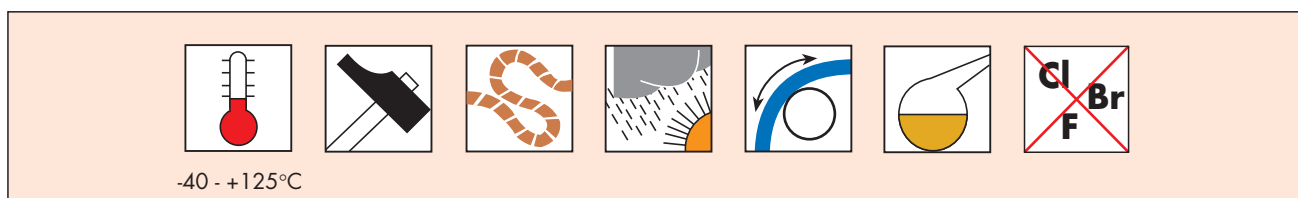

Engine and Transmission – Trend towards high-temperature cables



For wiring in the field of engines and transmissions, in addition to the well-established PVC, high-temperature solutions are being increasingly used.

The encapsulation of engines and new applications give rise to requirements for cables for high

operating temperatures. Nexans offers a wide range of cables for temperatures ranging from +105°C to +260°C (3000 hrs). In addition, Nexans supplies various gear boxes cables and sensor cables for oxygen and NOx sensors in direct fuel injection engines.

Products for Engine and Transmission

Product	Cores	Cross section	Temperature (3000 h)	Application	Page
FLRY-A	1	0,22 - 2,5 mm ²	- 40 to + 105 °C	Engine and Transmission Comfort and Car body	20
FLRY-B	1	0,35 - 6,0 mm ²	- 40 to + 105 °C	Engine and Transmission Comfort and Car body	21
FLRX	1	0,5 - 6,0 mm ²	- 40 to + 105 °C	Engine and Transmission	22
FLR13Y	1	0,5 - 6,0 mm ²	- 40 to + 110 °C	Engine and Transmission	23
FLR2X	1	0,35 - 6,0 mm ²	- 40 to + 125 °C	Engine and Transmission	24
FLR7Y	1	0,35 - 4,0 mm ²	- 65 to + 180 °C	Engine and Transmission	25
FLR6Y	1	0,35 - 4,0 mm ²	- 65 to + 210 °C	Engine and Transmission	26
FLR14Y	1	0,5 - 4,0 mm ²	- 80 to + 260 °C	Engine and Transmission	27
FLR5Y	1	AWG 18 - 22	- 65 to + 260 °C	Engine and Transmission	28
FLR2XHX	2 - 10	0,75 mm ²	- 40 to + 135 °C	Engine and Transmission Safety and Chassis	29
FLR7Y12X	2 - 16	0,35 - 0,75 mm ²	- 40 to + 150 °C	Engine and Transmission	30
FLR7YB12X	3 - 5	0,5 mm ²	- 40 to + 150 °C	Engine and Transmission	30

New development: 125 °C engine wire

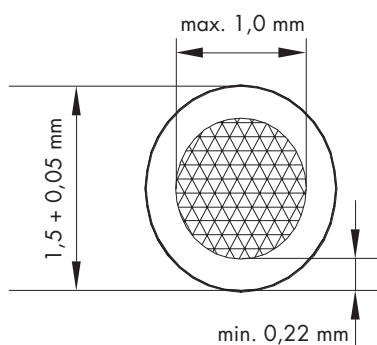

FLR2X 0,5 mm²

- very good mechanical properties
- good resistance against chemical agents
- compatible with all established cable systems
- halogen free, flame retardant
- no corrosive fire gases and very low smoke in case of fire

Product	FLR2X
Structures	0,35 mm ² - 6,0 mm ²
Conductor	bare copper
Insulation	irradiation cross linked PE (XPE)
Temperature range	-40 °C to +125°C (3000 h) resp. +150°C (1250 h)
Specification	LV 112, ISO 6722 and BMW GS 95007

More information on page 24.

Application

Single core cable with symmetrical conductor structure (type A) and reduced wall thickness.



Structure

1. Conductor

Cu-ETP1 bare
acc. to DIN EN 13602

2. Insulation

PVC lead free
Shore A 93 ± 5 DIN 53 505

Standards

Structure and properties acc. to
ISO 6722 class B
LV 112

Marking

Manufacturer marking

Special types

- FLYH as high flexible type
- FLRYWd with better heat pressure resistance

Types

Designation	No. of cores x conductor cross section Nominal value No. x mm ²	Structure No. x max. Ø mm	Conductor Diameter Guiding value mm	max. conductor resistance (20 °C) Ω/km	Cores		Weight Guiding value kg/km
					Wall thickness min. mm	Diameter max. mm	
FLRY-A 0,22	1x0,22	7x0,21	0,70	84,8	0,20	1,2-0,1	3,1
FLRY-A 0,35	1x0,35	7x0,26	0,80	52	0,20	1,3-0,1	4,5
FLRY-A 0,5	1x0,5	19x0,19	1,0	37,1	0,22	1,6-0,2	6,6
FLRY-A 0,75	1x0,75	19x0,23	1,20	24,7	0,24	1,9-1-0,2	9,0
FLRY-A 1,0	1x1,0	19x0,26	1,35	18,5	0,24	2,1-0,2	11,0
FLRY-A 1,5	1x1,5	19x0,32	1,70	12,7	0,24	2,4-0,2	16,0
FLRY-A 2,5	1x2,5	19x0,41	2,20	7,6	0,28	3,0-0,3	26,0

Other constructions upon request.

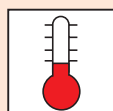

-40 - +105°C

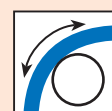
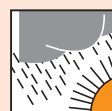

Application

Single core cable with non symmetrical conductor structure (type B) and reduced wall thickness.



Structure

1. Conductor

Cu-ETP1 bare
acc. to DIN EN 13602

2. Insulation

PVC lead free
Shore A 93 ± 5 DIN 53 505

Standards

Structure and properties acc. to
ISO 6722 class B
LV 112

Marking

Manufacturer marking

Engine and Transmission

Types

Designation	No. of cores x conductor cross section Nominal value No. x mm ²	Structure No. x max. Ø mm	Conductor Diameter Guiding value mm	max. conductor resistance (20 °C) Ω/km	Cores		Weight Guiding value kg/km
					Wall thickness min. mm	Diameter max. mm	
FLRY-B 0,35	1x0,35	12x0,21	0,9	52,0	0,20	1,4-0,2	4,5
FLRY-B 0,5	1x0,5	16x0,21	1,00	37,1	0,22	1,6-0,2	6,6
FLRY-B 0,75	1x0,75	24x0,21	1,20	24,7	0,24	1,9-0,2	9,0
FLRY-B 1,0	1x1,0	32x0,21	1,35	18,5	0,24	2,1-0,2	11,0
FLRY-B 1,5	1x1,5	30x0,26	1,70	12,7	0,24	2,4-0,3	16,0
FLRY-B 2,5	1x2,5	50x0,26	2,20	7,6	0,28	3,0-0,3	26,0
FLRY-B 4,0	1x4,0	56x0,31	2,75	4,7	0,32	3,7-0,3	42,0
FLRY-B 6,0	1x6,0	84x0,31	3,30	3,1	0,32	4,3-0,3	61,0

Other constructions upon request.

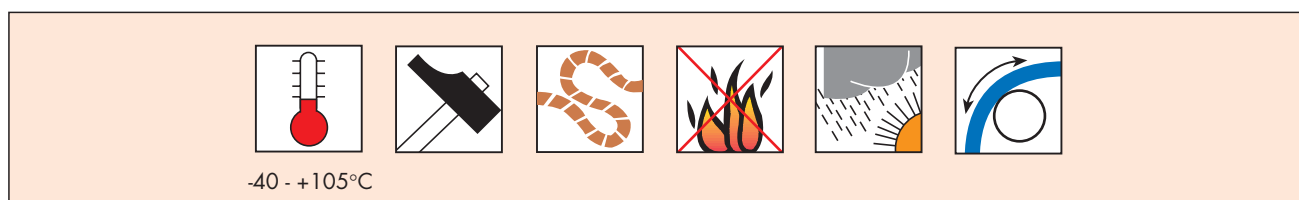

Application

Single core cable with tinned conductor, resistant against gearbox oil.



Structure

1. Conductor

Cu-ETP1 tinned
acc. to DIN EN 13602

2. Insulation

TPE-E
Shore D 72 ± 5 DIN 53 505

Standards

Structure and properties acc.to
ISO 6722 class D

Marking

Manufacturer marking

Special types

Resistance against gearbox
oil acc. to Ford specification
ESP-M2C 166-H

Types

Designation	No. of cores x conductor cross section Nominal value No. x mm ²	Structure No. x max. Ø mm	Conductor Diameter Guiding value mm	max. conductor resistance (20 °C) Ω/km	Cores		Weight Guiding value kg/km
					Wall thickness min. mm	Diameter max. mm	
FLR13Y 1x0,5	1x0,5	19x0,19	1	37,1	0,20	1,6-0,2	6
FLR13Y 1x0,75	1x0,75	19x0,23	1,2	24,7	0,22	1,9-0,2	9
FLR13Y 1x1,0	1x1,0	19x0,26	1,35	18,5	0,24	2,1-0,2	11
FLR13Y 1x1,5	1x1,5	19x0,32	1,7	12,7	0,24	2,4-0,2	16
FLR13Y 1x2,5	1x2,5	19x0,41	2,2	7,6	0,28	3,0-0,3	25
FLR13Y 1x4,0	1x4,0	56x0,31	2,75	4,71	0,32	3,7-0,3	40
FLR13Y 1x6,0	1x6,0	84x0,31	3,3	3,1	0,32	4,3-0,3	60

Other constructions upon request.

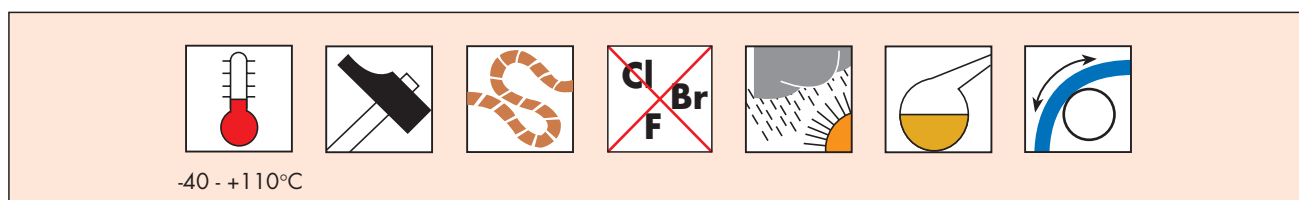

Application

Halogen free irradiation cross linked single core cable with very good mechanical properties, especially for the engine compartment (page 19).

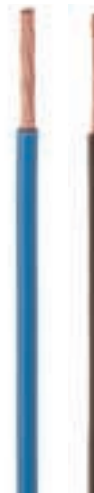

Structure

1. Conductor

Cu-ETP1 bare
acc. to DIN EN 13602

2. Insulation

irradiation cross linked PE, halogen free
Shore D 58 ± 5 DIN 53 505

Standards

Structure and properties acc. to ISO 6722, LV 112 and BMW GS 95007

Marking

Manufacturer marking

Types

Designation	No. of cores x conductor cross section Nominal value No. x mm ²	Structure No. x max. Ø mm	Conductor Diameter Guiding value mm	max. conductor resistance (20 °C) Ω/km	Cores		Weight Guiding value kg/km
					Wall thickness min. mm	Diameter max. mm	
FLR2X 0,35	1x0,35	7x0,26	0,8	52,0	0,20	1,3-0,1	4
FLR2X 0,5	1x0,5	19x0,19	1	37,1	0,22	1,6-0,2	6,6
FLR2X 0,75	1x0,75	19x0,22	1,2	24,7	0,24	1,9-0,2	9
FLR2X 1,0	1x1,0	19x0,26	1,3	18,5	0,24	2,1-0,2	11
FLR2X 1,5	1x1,5	19x0,32	1,7	12,7	0,24	2,4-0,2	16
FLR2X 2,5	1x2,5	19x0,40	2,2	7,6	0,28	3,0-0,3	26
FLR2X 2,5	1x2,5	50x0,26	2,2	7,6	0,28	3,0-0,3	26
FLR2X 4,0	1x4,0	56x0,30	2,7	4,7	0,32	3,7-0,3	42
FLR2X 6,0	1x6,0	84x0,30	3,2	3,1	0,32	4,3-0,3	61

Other constructions upon request.









-40 - +125°C/3000 h
or
+150°C/1250 h

Application

Single core cable,
especially for the engine compartment



Conductor

1. Conductor

Cu-ETP1 bare or tinned
acc. to DIN EN 13602

2. Insulation

ETFE
Shore D 70 ± 5 DIN 53 505

Standards

Structure and properties acc. to
ISO 6722 class D







Marking

Manufacturer marking

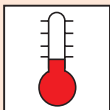
Ausführungen

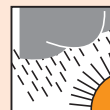
Designation	No. of cores x conductor cross section Nominal value No. x mm ²	Structure No. x max. Ø mm	Conductor Diameter Guiding value mm	max. conductor resistance (20 °C) Ω/km	Cores		Weight Guiding value kg/km
					Wall thickness min. mm	Diameter max. mm	
FLR7Y 1x0,35	1x0,35	12x0,21	0,9	52	0,20	1,4-0,2	5
FLR7Y 1x0,5	1x0,5	16x0,21	1	37,1	0,22	1,8-0,2	7
FLR7Y 1x0,75	1x0,75	24x0,21	1,2	24,7	0,24	1,9-0,2	8,5
FLR7Y 1x1,0	1x1,0	32x0,21	1,35	18,5	0,24	2,1-0,2	11
FLR7Y 1x1,5	1x1,5	30x0,26	1,7	12,7	0,24	2,4-0,3	16
FLR7Y 1x2,5	1x2,5	50x0,26	2,2	7,6	0,28	3,0-0,3	26
FLR7Y 1x4	1x4,0	56x0,31	2,75	4,7	0,32	3,7-0,3	41

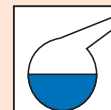
Other constructions upon request.

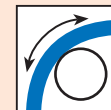
-65 - +180°C

Application

Single core cable,
especially for the engine compartment



Structure

1. Conductor

Cu-ETP1 bare or tinned
acc. to DIN EN 13602

2. Insulation

FEP
Shore D 55 ± 5 DIN 53 505

Standards

Structure and properties acc. to
ISO 6722 class E

Marking

Manufacturer marking

Types

Designation	No. of cores x conductor cross section Nominal value No. x mm ²	Structure No. x max. Ø mm	Conductor Diameter Guiding value mm	max. conductor resistance (20 °C) Ω/km	Cores		Weight Guiding value kg/km
					Wall thickness min. mm	Diameter max. mm	
FLR6Y 1x0,35	1x0,35	12x0,21	0,9	52	0,20	1,4-0,2	5
FLR6Y 1x0,5	1x0,5	16x0,21	1	37,1	0,22	1,6-0,2	7
FLR6Y 1x0,75	1x0,75	24x0,21	1,2	24,7	0,24	1,9-0,2	8,5
FLR6Y 1x1,0	1x1,0	32x0,21	1,35	18,5	0,24	2,1-0,2	11
FLR6Y 1x1,5	1x1,5	30x0,26	1,7	12,7	0,24	2,4-0,3	16
FLR6Y 1x2,5	1x2,5	50x0,26	2,2	7,6	0,28	3,0-0,3	26
FLR6Y 1x4	1x4,0	56x0,31	2,75	4,7	0,32	3,7-0,3	41

Other constructions upon request.

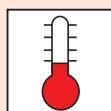

-65 - +210°C

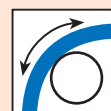
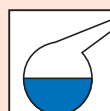
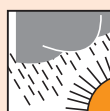

Application

Single core cable with very good resistance against chemicals, can be used as an alternative to PTFE

Structure

1. Conductor

Cu-OF1 silver plated
acc. to DIN EN 13602

2. Insulation

PFA
Shore D 58 ± 5 DIN 53 505



Standards

Structure and properties acc. to ISO 6722 class H

Marking

Manufacturer marking

Types

Designation	No. of cores x conductor cross section Nominal value No. x mm ²	Structure No. x max. Ø mm	Conductor Diameter Guiding value mm	max. conductor resistance (20 °C) Ω/km	Cores		Weight Guiding value kg/km
					Wall thickness min. mm	Diameter max. mm	
FLR14Y 0,5	1x0,5	19x0,19	1	38,2	0,22	1,6-0,2	7
FLR14Y 0,75	1x0,75	19x0,22	1,2	25,4	0,24	1,9-0,2	10
FLR14Y 1,0	1x1,0	19x0,25	1,35	19,1	0,24	2,1-0,2	12
FLR14Y 1,5	1x1,5	19x0,32	1,7	13	0,24	2,4-0,2	17
FLR14Y 2,5	1x2,5	19x0,40	2,2	7,8	0,28	3,0-0,3	28
FLR14Y 4,0	1x4,0	56x0,30	2,7	4,8	0,32	3,7-0,3	45

Other constructions upon request.



Application

Single core cable with very good properties, e.g. for the connection of oxygen sensors or NO_x-sensors.



Structure

1. Conductor

Cu-OF1 nickel plated
acc. to DIN EN 13602

2. Insulation

PTFE
Shore D 55 ± 5 DIN 53 505

Standards

Different customer specifications

Marking

Manufacturer marking

Special characteristics

* Special cable with defined air permeability

Types

Designation	No. of cores x conductor cross section Nominal value No. x mm ²	Structure No. x max. Ø mm	Conductor Diameter Guiding value mm	max. conductor resistance (20 °C) Ω/km	Cores		Weight Guiding value kg/km
					Wall thickness min. mm	Diameter max. mm	
FLR5Y(HXN22)	1xAWG 22	19x0,16	0,76	52,5	0,32	1,55	6
FLR5Y(HXN20)	1xAWG 20	19x0,203	0,98	32,5	0,30	1,68	8
FLR5Y(HXN20)	1xAWG20	*19x0,203	0,98	32,5	0,30	1,68	8
FLR5Y(HXN18)	1xAWG18	19x0,247	1,21	20,0	0,32	1,94	13

Other constructions upon request.

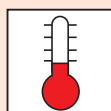

-40 - +260°C

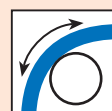
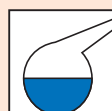
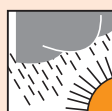

Application

Multi core connection cable with halogen free core and sheath

insulation, e.g. for gear box connections.



Structure

1. Conductor

Cu-ETP1 bare
acc. to DIN EN 13602

3. Sheath

Halogen free irradiation cross linked HX
Shore A 90 ± 5, sheath colour: black

2. Insulation

Halogen free irradiation
cross linked PE
Shore D 59 ± 5 DIN 53 505

Standards

Different customer specifications

Marking

Manufacturer marking



Types

Designation	No. of cores x conductor cross section Nominal value No. x mm ²	Structure No. x max. Ø mm	Conductor Diameter Guiding value mm	max. conductor resistance (20 °C) Ω/km	Cores		Sheath		Weight Guiding value kg/km
					Wall thickness min. mm	Diameter max. mm	Wall thickness Guiding value mm	Outer- diameter Nominal value mm	
FLR2XHX 2x0,75	2x0,75	24x0,21	1,1	25,4	0,24	1,8	0,59	5,2±0,2	40
FLR2XHX 3x0,75	3x0,75	24x0,21	1,1	25,4	0,24	1,8	0,59	5,4±0,2	48
FLR2XHX 10x0,75	10x0,75	24x0,21	1,1	25,4	0,24	1,8	0,59	9,0±0,2	130

Other constructions upon request.



FLR7Y12X/FLR7YB12X

Application

Shielded sheathed cable for applications in the high

temperature areas of cars, e.g. for gear box connections.

Structure

1. Conductor

Cu-ETP1 tinned
acc. to DIN EN 13602

3. Shield

FLR7Y12X: –
FLR7YB12X: PT/AL-foil screen
with drain wire

2. Insulation

ETFE
VDE 0207 T.6
Shore D 70 ± 5 DIN 53 505

4. Sheath

X-TPE-E
Shore A 88 ± 5 DIN 53 505



Standards

Different customer specifications

Marking

Manufacturer marking

Special characteristics

Flame retardant, resistant against oil, fuel and ozon

Types

Description	No. of cores x conductor cross section Nominal value No. x mm ²	Structure No. x max. Ø mm	conductor Diameter Guiding value mm	max. conductor resistance (20 °C) Ω/km	Cores		Sheath		Weight Guiding value kg/km
					Wall thickness min. mm	Diameter max. mm	Wall thickness Guiding value mm	Outer diameter Nominal value mm	
FLR7Y12X 4x0,5+1x0,75	4x0,5 1x0,75	19x0,19 19x0,23	0,9 1,15	38,2 25,4	0,10 0,10	1,35 1,5	0,58	5,2 ± 0,25	57
FLR7Y12X 2x0,5	2x0,5	19x0,19	0,9	38,2	0,10	1,25	0,32	3,5 ± 0,2	22
FLR7Y12X 2x2x0,35+ 11x0,5+ 1x0,75	2x2x0,35 11x0,5 1x0,75	7x0,25 19x0,18 19x0,23	0,75 0,9 1,15	54,5 38,2 25,4	0,10 0,10 0,10	1,05 1,30 1,45	1,00	9,2 ± 0,2	155
FLR7YB12X 2x0,5+0,5	2x0,5 1x0,5	19x0,19 19x0,19	0,9	38,2	0,1	1,30	0,41	4,1 ± 0,1	31
FLR7YB12X 4x0,5+0,5	4x0,5 1x0,5	19x0,19 19x0,19	0,9	38,2 38,2	0,1	1,30	0,5	5,2 ± 0,2	50

Other constructions upon request.

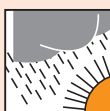
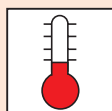

-40 - +150°C (3000 h)
+180°C (48 h)

Comfort and Car body – from standard to special cables



Modern cars are not conceivable without comfort functions.

For electric seat, windscreen or mirror adjustment systems – with a wide range of cables, Nexans offers the optimal solution in terms of price, quality and logistics.

Our modern plant in Romania (see below) is specialised in the production of standard cables. However, for special solutions, e.g. fluoropolymer cables for seat heating systems, Nexans is also your ideal partner.

Products for Comfort and Car body

Product	Cores	Cross section	Temperature (3000 h)	Application	Page
FLY	1	0,5 - 6,0 mm ²	- 40 °C to +105 °C	Comfort and Car body	32
FLRY-A	1	0,35 - 6,0 mm ²	- 40 °C to +105 °C	Comfort and Car body Engine and Transmission	20
FLRY-B	1	0,35 - 6,0 mm ²	- 40 °C to +105 °C	Comfort and Car body Engine and Transmission	21
FLYY	1	0,5 - 2,5 mm ²	- 40 °C to +105 °C	Comfort and Car body	33
FLYY	2	0,5 - 1,0 mm ²	- 40 °C to +105 °C	Comfort and Car body	34
FLRYY	2	0,5 mm ²	- 40 °C to +105 °C	Comfort and Car body Safety and Chassis	12
Flat cables				Comfort and Car body	35

Nexans Romania: Efficiency for standard cables



With the set-up of a new plant in Romania, Nexans responded to the fact that an increasing number of manufacturers are transferring their production to Eastern Europe. Nexans Romania, with its modern production installations and a slender structure, is oriented towards the efficient production of standard cables for the automotive industry.

- Production of FLRY cables (page 20 and 21) for Germany and the Eastern European region
- Approvals of various OEMs
- Extension of product range planned
- ISO/TS 16949:2002 and ISO 9001:2000 certification

Comfort and Car body

Application

Cable e.g. for car body harnessing



Structure

1. Conductor

Cu-ETP1 bare
acc. to DIN EN 13602

2. Insulation

PVC lead free
Shore A 93 ± 5 DIN 53 505

Standards

ISO 6722 class B

Marking

Manufacturer marking

Types

Designation	No. of cores x conductor cross section Nominal value No. x mm ²	Structure No. x max. Ø mm	Conductor Diameter Guiding value mm	max. conductor resistance (20 °C) Ω/km	Cores		Weight Guiding value kg/km
					Wall thickness min. mm	Diameter max. mm	
FLY 1x0,5	1x0,5	16x0,21	0,9	37,1	0,44	2,15 ± 0,1	8
FLY 1x0,75	1x0,75	24x0,21	1,1	24,7	0,44	2,35 ± 0,1	12
FLY 1x1,0	1x1,0	32x0,21	1,35	18,5	0,48	2,5 ± 0,1	15
FLY 1,5	1x1,5	30x0,26	1,7	12,7	0,48	2,8 ± 0,1	20
FLY 2,5	1x2,5	50x0,26	2,2	7,6	0,56	3,4 ± 0,1	32
FLY 4	1x4,0	56x0,31	2,75	4,71	0,64	4,2 ± 0,1	49
FLY 6	1x6,0	84x0,31	3,3	3,14	0,64	4,8 ± 0,1	68

Other constructions upon request.

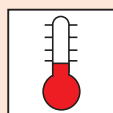

-40 - +105°C

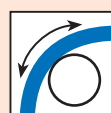

Application

Double insulated cable e.g. for car body harnessing



Structure

1. Conductor

Cu-ETP1 bare
acc. to DIN EN 13602

3. Shield

–

2. Insulation

PVC lead free
Shore A 93 ± 5 DIN 53 505
ISO 6722 class B

4. Sheath

PVC lead free
Shore A 86 ± 5
DIN 53 505
various sheath colours

Standards

Different customer specifications

Marking

Manufacturer marking

Types

Designation	No. of cores x conductor cross section Nominal value No. x mm ²	Structure No. x max. Ø mm	Conductor		Cores		Sheath		Weight Guiding value kg/km
			Diameter Guiding value mm	max. conductor resistance (20 °C) Ω/km	Wall thickness min. mm	Diameter Guiding value mm	Wall thickness Guiding value mm	Outer diameter Nominal value mm	
FLYY 1x0,5	1x0,5	16x0,20	0,9	37,1	0,6	2,1	0,4	2,9 ± 0,2	14
FLYY 1x0,75	1x0,75	24x0,20	1,1	24,7	0,6	2,3	0,4	3,2 ± 0,2	17
FLYY 1x1,0	1x1,0	32x0,20	1,35	18,5	0,6	2,5	0,4	3,4 ± 0,2	20
FLYY 1x1,5	1x1,5	30x0,26	1,7	12,7	0,6	2,8	0,5	3,9 ± 0,2	28
FLYY 1x2,5	1x2,5	19x0,404	2,0	7,5	0,35	2,9	0,5	4,2 ± 0,2	37
FLYY 1x2,5	1x2,5	50x0,26	2,2	7,6	0,7	3,5	0,5	4,5 ± 0,2	41

Other constructions upon request.

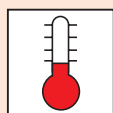

-40 - +105°C

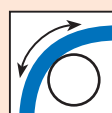
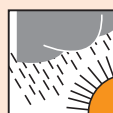

Application

PVC cable with two cores
e.g. for car body harnessing

Structure

1. Conductor

Cu-ETP1 bare
acc. to DIN EN 13602

2. Isolierung

PVC lead free
Shore A 95 ± 5 DIN 53 505
ISO 6722 class B

3. Sheath

PVC lead free
Shore A 86 ± 5 DIN 53 505
various sheath colours



Standards

Different customer specifications

Marking

Manufacturer marking

Types

Designation	No. of cores x conductor cross section Nominal value No. x mm ²	Structure No. x max. Ø mm	Conductor Diameter Guiding value mm	max. conductor resistance (20 °C) Ω/km	Cores		Sheath		Weight Guiding value kg/km
					Wall thickness min. mm	Diameter Guiding value mm	Wall thickness Guiding value mm	Outer diameter Nominal value mm	
FLYY 2x0,5	2x0,5	16x0,20	0,9	37,1	0,35	1,9	0,41	5,2 ± 0,2	37
FLYY 2x1,0	2x1,0	32x0,20	1,2	18,5	0,6	2,45	0,67	7,8 ± 0,2	94

Other constructions upon request.

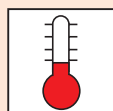

-40 - +105°C

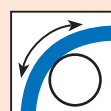
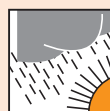

Detecting new trends – Nexans flexible flat cables

Laminated flexible flat cables

FFC (Flexible Flat Cable) technology is one of the most discussed subjects in the automotive industry in recent years. Laminated FFCs have been used successfully for a long time in cars, particularly for airbag wiring (clock spring) and, to a certain extent, for roof and door harnesses.

The advantages of these laminated FFCs with respect to round cables are:

- lower space requirements
- lower weight
- high flexibility
- high fatigue strength
- precise grid dimension and low tolerances
- as a result, processing can be easier automatized
- secure bonding due to precise arrangement



For clock springs, Nexans offers a multitude of different laminated FFCs. Further information is available on request.

Extruded flexible flat cables

Extruded FFCs represent a relatively recent development. While, in laminated FFCs, the flat copper strip wire is laminated between two layers of foil, the production process of extruded FFCs is similar to conventional cables. The insulating material is deposited as a homogeneous mass on the wire via a special extrusion head. In this way, it is possible to use bare, tin-plated or silver-plated wires, which Nexans sometimes produces in its own production facilities by means of rolling. Unlike cut wires, this process guarantees round edges.

Overall, extruded FFCs show a range of advantages with respect to laminated solutions:

- Use of standard materials in the cable industry, including fluoropolymers, halogen-free and cross-linked insulating materials
- improved longitudinal water density due to homogeneous insulation
- rounded cable edges
- improved hydrolysis and media properties in the case of the use of suitable insulating materials

Due to these many advantages, an increased use, particularly of extruded FFCs, in the automotive industry is to be expected.

Nexans Nuremberg tackled this new approach early on and is your expert correspondent for development projects in this area.



Production of flat copper conductors at Nexans

Control and Multimedia – High-tech applications require new solutions for the future



Whether navigation or DVD entertainment systems are involved, more and more new vehicle control functions and passenger entertainment are found in new motor vehicles.

In particular, driving assistance systems, ranging from rear camera to traffic lane detection and distance radars are the focus

of development and will become established in the different vehicle categories.

Nexans has an extensive range of special cables for these systems. With our development expertise in the fields of bus and coaxial cables, we are well prepared for joint projects.

Products for Control and Multimedia

Product	Cores	Cross section	Temperature (3000 h)	Application	Page
FL02YSBY CAN3	1 x 2	0,22 mm ²	- 40 °C to +90 °C	Control and Multimedia	38
Coaxial cables			- 40 °C to +200 °C	Control and Multimedia	40 - 41
ELCURIGID®			- 40 °C to +130 °C	Control and Multimedia	39

New standards for bus cables

The increase in driving assistance systems with their underlying sensors and actuators and their future networking set new requirements for the onboard system, which cannot be fully met by the current CAN bus:

- Time- (deterministic) instead of event-dependent control
- Reliability (redundancy, availability, failsafe operation)
- Broad bandwidth (transmission speed, data volume)

New standards such as Flexray will meet these requirements. In the future, Flexray will more than likely play an important role as a transmission protocol for bus systems along with CAN, LIN and MOST.

In addition to CAN cables as part of the regular production programme (see page 38), Nexans has also conducted initial projects with cables following the Flexray standard and also has its many years of experience to offer for new developments.

FL02YSBY CAN3

Application

Connection cable for transmission of digital signals up to a Baud rate of 1 M Baud inside cars.



Structure

1. Conductor

1 x CrNi-steel (0,2 mm²)
+ 6 x Cu bare

3. Shield

Plastic backed Aluminum foil with drain wire Cu tinned
0,35 mm²

2. Insulation

Foam Skin Polyethylen

4. Sheath

PVC lead free
Shore A 86 ± 5

Standards

Characteristic Impedance:
100 kHz 105 Ohm+20 Ohm
500 kHz 95 Ohm+20 Ohm
1000 kHz 90 Ohm +20 Ohm

Marking

Manufacturer marking

Types

Designation	No. of cores x conductor cross section Nominal value No. x mm ²	Conductor		Cores		Sheath		Weight Guiding value kg/km
		Structure No. x max. Ø mm	Diameter Guiding value mm	Wall thickness min. mm	Diameter Guiding value mm	Wall thickness Guiding value mm	Outer diameter Nominal value mm	
FL-02YSBY 1x2x0,22+0,35	1x2x0,22	1xCuNi-Stahl + 6xCu blk	0,6	0,3	1,2	0,55	3,8+0,1	25

Other constructions upon request.

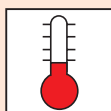

-40 - +90°C

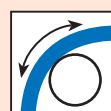
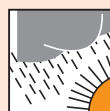

Application

Highly shielded coaxial cables.
Example: type 141-50 FEP with

tinned braid and max. operating
temperature of 260°C

Structure

1. Conductor

Cu silver plated
+ 6 x Cu bare

3. Shield

tinned copper braid

2. Dielectric

Teflon-PTFE 5Y11
acc. to VDE 0207 part 5

4. Sheath

Teflon-FEP



Standards

IEC 61196-1
IEC 60096-0-1
IEC 61196-1
Standard: VDE 0276
burning behaviour: DIN EN 50 265-2-1

Marking

Marking of power as an option

Colours of core

transparent dielectric

Types overview ELCURIGID

Types	Characteristic Impedance IEC 61196-1 11.8.1 Ω	Capacitance IEC 61196-1 11.3 pF/m	Shield Attenuation IEC 61196-1 12.6 dB	Insulation Resistance of dielectric IEC 61196-1 11.2 G Ω · km	Test voltage IEC 61196-1 11.5 50 Hz, 1 min kV eff	Backflow Attenuation IEC 61196-1 11.12 dB	Attenuation IEC 61196-1 13.6 typ./Max.		max. allowed power and duty voltage IEC 60096-0-1 P [W] P [W] U [V] U [V]	
							1000 MHz	2000 MHz	1000 MHz	2000 MHz
ECR 86-50-FEP	50 ± 2	97	≥ 80 dB at 10 MHz	10	2,0	25 dB with	73,8/ 82	110/ 125	165 90	110 75
ECR 141-50-FEP	50 ± 2	97	up to 2000 MHz	10	4,0	single peaks up to	40,2 47	60,1 70	485 150	320 120
ECR 250-50-FEP	50 ± 2	97	repeated bending is deteriorating the attenuation	10	7,0	20 dB at 50 MHz up to 2000 MHz	23,8 28	36,3 42	1220 250	820 200

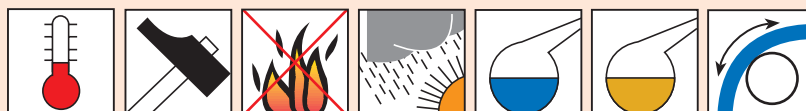

-40 - +150°C



Coaxial cables

Application

As antenna cable e.g. for navigation systems (GPS), car radios or car phones

Types

- 50 or 75 Ω
- RG 178, RG 316, RG 174, RG 58, RG 59, RG 179
- Single and double attenuation
- PE / PP / foamed PE / XLPE / FEP / PTFE Insulation



Advantages

- High temperature cables (up to 200°C)
- Sheath for applications with high mechanical stress
- Easy contacting
- Small and flexible cables
- Conductors and cross sections compatible with standard connectors
- Big range of customer specific coaxial cables

Types

	Description	Temperature °C	Gauge (AWG)	Conductor Construction No. x Ø mm	Material*	Dielectric (2)		Shield Material (3)		Sheath (4)	
						Diameter mm	Material	Diameter mm	Material	Material	Outer diameter mm
50 Ω types											
RG 178 and variants	RG 178 FEP/ETFE	150	30	7x0,10	CCS	0,3	FEP	0,8	BC	ETFE	1,8
	RG 178 XLPE/PVC	125	30	7x0,10	TPC or CCS	0,3	XLPE	0,9	BC	PVC	1,8
	RG 178 PTFE/FEP	200	30	7x0,10	SPCCS	0,3	PTFE	0,8	SPC	FEP	1,8
RG 316 and variants	RG 316 FEP/TPE	125	26	7x0,175	TPC	0,5	FEP	1,5	TPC	TPE	2,5
	RG 316 FEP/FEP	200	26	7x0,175	SPCCS	0,5	FEP	1,5	SPC	FEP	2,5
	RG 316 PTFE/FEP	200	26	7x0,175	SPCCS	0,5	PTFE	1,5	SPC	FEP	2,5

Types

	Description	Temperature °C	Gauge (AWG)	Conductor Construction No. x Ø mm	Material*	Dielectric (2)		Shield Material (3)		Sheath (4)	
						Diameter mm	Material	Diameter mm	Material	Material	Outer diameter mm
50 Ω types											
RG 174 and variants	RG 174 PE/PVC	85	26	7x0,16	Bronze or CCS	0,48	PE	1,52	TPC	PVC	2,54 or 2,76
	RG 174 PP/PVC	105	26	7x0,16	TPC	0,48	PP	1,52	TPC	PVC	2,76
	RG 174 XLPE/PVC	125	26	7x0,16	Bronze or CCS	0,48	XPE	1,52	Poly/A L+TPC	PVC	2,76
	RG 174 FEP/TPE	125	26	7x0,16	Bronze	0,48	FEP	1,46	TPC	TPE	2,76
RG 58	RG 58 PE/PVC	85	20	19x0,185		0,9	PE	2,95	TPC	PVC	4,95
High Performance cables	foamed PE/PVC (low loss)	80	22	7x0,27	BC	0,80	foamed PE	2,1	AL/Poly/ AL foil+ TPC	PVC	3,20
	foamed PE/ Polyamide	105	20	19x0,20	TPC	0,98	foamed PP	2,75	Poly/A L+TPC	Poly- amide	3,60
	ETFE/ETFE (miniaturized)	150	28	7x0,13	TPC	0,39	ETFE	0,67	TPC	ETFE	1,45
	PTFE/FEP (miniaturized)	200	30	1x0,30	SPCCS	0,3	PTFE	0,89	SPC	FEP	1,45
75 Ω Ausführung											
RG 179 and variants	RG 179 PP/PVC	105	30	7x0,10	SPCCS	0,3	PP	1,6	TPC	PVC	2,54
	RG 179 FEP/FEP	200	30	7x0,10	SPCCS	0,3	FEP	1,6	SPC	FEP	2,54
	RG 179 PTFE/FEP	200	30	7x0,10	SPCCS	0,3	PTFE	1,6	SPC	FEP	2,54
RG 59	RG 59 (miniaturized)	85°C	24	7 x 0,20	BC	0,6	foamed PE	2,50	BC	PVC	3,70
High Perfor- mance cables	RG 58 75 Ω PE/PVC	85°C	26	7 x 0,15	TPC	0,9	PE	2,95	TPC	PVC	4,95
	foamed PE/PVC (miniaturized)	85°C	28	7 x 0,13	TPC	0,39	foamed PE	1,79	TPC	PVC	2,54

*Abbreviation

BC: bare copper

CCS: copper clad steel

SPC: silver plated copper

SPCCS: silver plated copper

TPC: tinplated copper



About Nexans

Nexans



Nexans is a worldwide leading manufacturer in the cable industry. The group offers an extensive product range of the latest copper and optical cables for the infrastructure, industrial and construction markets.

Nexans cable and system solutions are used in all areas of life: telecommunications, data and power cable networks in aircraft and aerospace technology, the automotive industry, rail technology, construction technology and applications in the petrochemical industry and medical technology.

Our Markets

Infrastructure

Telecom and rail mains systems, Power supply companies, etc.

We supply these sectors on a day-to-day basis with high-performance cables and accessories and work continuously on new, innovative solutions

Industry

Motor industry, aircraft and aerospace, naval construction, oil, gas and rail industry

Our cables not only offer optimal performance and safety, they also cover specific customer requirements.

Construction

Fitters, wholesale dealers, engineering firms and major groups, etc.

They all use our cables and systems, in order to meet the strictest safety standards – in the private and industrial sector.

Nexans has know-how, global resources, performance and the ability to set up partnerships, which only a worldwide experienced cable manufacturer can offer.

agencies in 65 countries, Nexans generated, with 20,000 employees, a turnover of 4.9 billion Euro in 2004. Nexans is quoted on the Paris stock exchange.

With production plants in 29 countries and offices and

For more information, go to www.nexans.com

Nexans Nuremberg



The Nuremberg plant has a successful 100-year history behind it.

A strategic reorganisation has led in recent years to a focus on the following main areas:

Automotive industry

Sensor cables, transmission cables, temperature-resistant single wires and sheath cables

Industry and automation

Robotic cables, chain cables, bus cables, sensor cables and control cables

Cables and cable sets for rail vehicles

BUS cables, coaxial cables, control cables

Household and lamp industry

Single core and multi core cables (harmonized, halogen free and UL/CSA approved types)

High-temperature cables

Safety cables

Nexans Germany

Nexans Germany is one of the leading cable manufacturers in Europe. The company offers an extensive range of high-performance cables, systems and components for the telecommunications and power sector. The range is completed by superconductive materials and

components, cryoflex transfer systems and special machines for the cable industry.

The products are manufactured domestically and internationally with approx. 3550 employees. For more information, go to www.nexans.de

Quality management in Nexans Nuremberg

The plant in Nuremberg is both ISO 9001 and ISO/TS 16949-certified. Foresighted quality planning with well-known methods and an active continuous

improvement process ensure the outstanding level of quality and thus meet the strictest automotive industry requirements.



ISO 9001 Certificate



ISO/TS 16949 Certificate

Packaging systems

According to the customer's wishes and the type of cable, Nexans offers various types of packaging systems:

Barrels

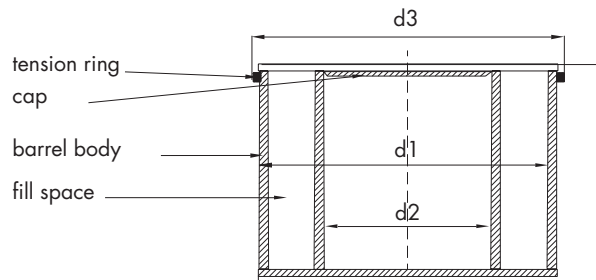

Description	d1 mm	d2 mm	d3 mm	h mm	Theoretical volume dm ³	DB flat pallet 1200 x 800 mm
M 500 x 400	500	315	530	400	41,4	6 barrels (stack of 2)
M 500 x 800	500	315	530	800	86,4	3 barrels

Spools

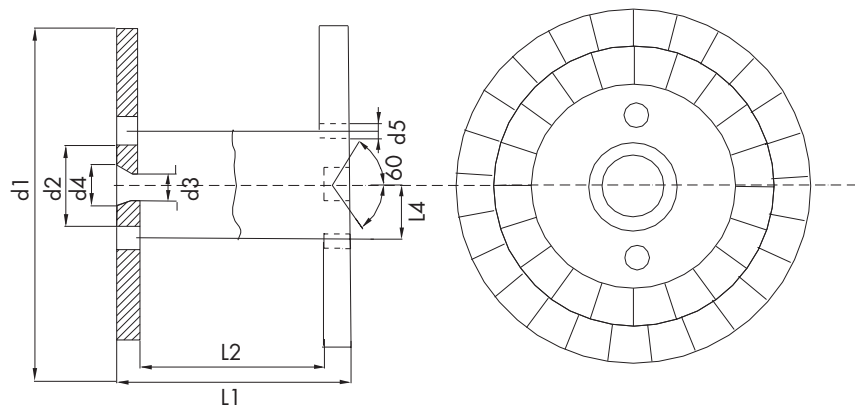

Description of spools	d1 mm	d2 mm	L2 mm	Weight kg	Theoretical volume dm ³
E05 (wood)	470	150	404	3	63
E08 (wood)	760	400	470	10	155
E10 (wood)	1000	470	500	22	306

Packaging systems

NPS coils

Description

Conical plastic coils with removable cover and fastening system. 6 coils, covered with a cardboard cover and secured with plastic hoops, fit onto a European pallet.

Two or four pallets, depending on the type of coil, are stacked on top of each other and loaded into a truck.

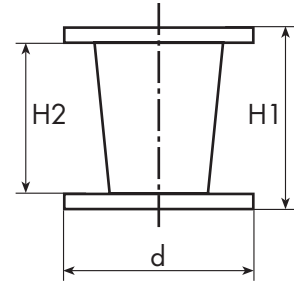

Advantages

- Easy unreeling even at high processing speeds
- Convenient return of packaging costs due to disassembly
- Resistant structure and material enable a long service life
- Environmentally friendly, since all materials are recyclable

CB cardboard box

Description

Specially developed boxes made from resistant multi-layer cardboard. The dimensions offer optimal space for 6 boxes per standard European pallet. Each box is closed with a cardboard cover and is secured with plastic hoops.

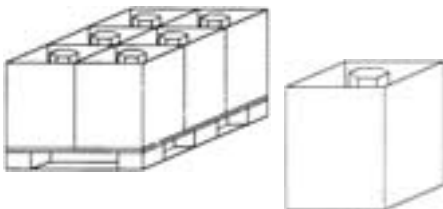
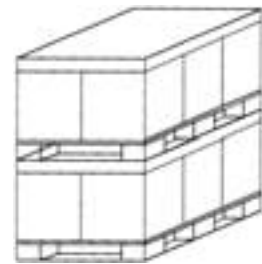

Advantages

- No costs for unused storage space by empty packaging
- Environmentally friendly due to recyclable materials
- Compact and easy handling

Overview

type	d mm	H1 mm	H2 mm	Theoretical volume dm ³	Number of spools/Europallet 1200 x 800 mm
NPS 400	400	463	400	31,6	6 spools/pallet max. 2 pallets on stack
NPS 250	400	313	250	21,4	6 spools/pallet max. 4 pallets on stack
Card board box	400	400	500	31,6	6 boxes/pallet max. 2 pallets on stack

Quotation Request form

Fax +49/911/5207-248

Company*: _____ Contact person*: _____

Phone no. *: _____ Fax no. *: _____ eMail: _____

Product description*: _____

Quantity*: _____ km batch quantity: _____ km SOP: _____

Price indication: _____ EUR/km copper base: _____ EUR/100 kg OEM: _____

Construction of cable

No. of cores*	Cross section*	Conductor construction	Outer diameter	Wall thickness cores	Wall thickness sheath	Colour of cores	Colour of sheath

Conductor: bare tin plated nickel plated silver plated

Insulation material: _____ Sheath material: _____

Shield: _____

Comments: _____

Requirements

Area of use: _____

Standard/customer specifications*: _____ test standards: _____

Operating temperature*: from - _____ °C up to + _____ °C at 48 h 3000 h _____ h

Chemical properties/environmental influences: _____

Electrical properties: _____

Bending requirements: laid fix laid flexible – smallest bending radius: _____ mm

Further processing

Processing: manually automatically with colour recognition system

Stripping force: core insulation: min: _____ max: _____ in N/cm (Standard N/5 cm)

sheath insulation: min: _____ max: _____ in N/cm

Injection moulded parts yes no Material: _____

Others

Packaging: coils barrel spools _____

Smallest acceptable length in m _____

Delivery address/- conditions: _____

Comments: _____

 Nexans